

X-431 Heavy-Duty

Automobile Diagnostic Platform

User's Manual
(First Edition)



LAUNCH
www.cnlaunch.com

Trademark Information

LAUNCH is a registered trademark of LAUNCH TECH. CO., LTD. (also called LAUNCH for short) in China and other countries. All other LAUNCH trademarks, service marks, domain names, logos, and company names referred to in this manual are either trademarks, registered trademarks, service marks, domain names, logos, company names of or are otherwise the property of LAUNCH or its affiliates. In countries where any of the LAUNCH trademarks, service marks, domain names, logos and company names are not registered, LAUNCH claims other rights associated with unregistered trademarks, service marks, domain names, logos, and company names. Other products or company names referred to in this manual may be trademarks of their respective owners. You may not use any trademark, service mark, domain name, logo, or company name of LAUNCH or any third party without permission from the owner of the applicable trademark, service mark, domain name, logo, or company name. You may contact LAUNCH by visiting Launch at <http://www.cnlaunch.com>, or writing to LAUNCH TECH. CO., LTD., Launch Industrial Park, North of Wuhe Avenue, Banxueqiang, Bantian, Longgang, Shenzhen, Guangdong, P.R.China, to request written permission to use Materials on this manual for purposes or for all other questions relating to this manual.

Copyright Information

Copyright © 2007 by LAUNCH TECH. CO., LTD. All rights reserved. No part of this publication may be reproduced, stored in a retrieval system, or transmitted in any form or by any means, electronic, mechanical, photocopying, recording or otherwise, without the prior written permission of LAUNCH. The information contained herein is designed only for the use of this unit. LAUNCH is not responsible for any

use of this information as applied to other units. Neither LAUNCH nor its affiliates shall be liable to the purchaser of this unit or third parties for damages, losses, costs, or expenses incurred by purchaser or third parties as a result of: accident, misuse, or abuse of this unit, or unauthorized modifications, repairs, or alterations to this unit, or failure to strictly comply with LAUNCH operating and maintenance instructions.

LAUNCH shall not be liable for any damages or problems arising from the use of any options or any consumable products other than those designated as Original LAUNCH Products or LAUNCH Approved Products by LAUNCH.

General Notice

- Other product names used herein are for identification purposes only and may be trademarks of their respective owners. LAUNCH disclaims any and all rights in those marks.
- There is a possibility that this unit is inapplicable to some of the vehicle models or systems listed in the diagnosis section due to different countries, areas, and/or years. Do not hesitate to contact LAUNCH if you come across such questions. We are to help you solve the problem as soon as possible.

Disclaimer

- To take full advantage of the unit, you should be familiar with the engine.
- All information, illustrations, and specifications contained in this manual are based on the latest information available at the time of publication. The right is reserved to make change at any time without notice.

End User License Agreement

IMPORTANT: PLEASE READ THIS END USER LICENSE AGREEMENT CAREFULLY. USING LAUNCH OR LAUNCH-SUPPLIED PRODUCTS AND SOFTWARE CONSTITUTES ACCEPTANCE OF THIS AGREEMENT.

LAUNCH IS WILLING TO LICENSE THE PRODUCTS, INFORMATION, SOFTWARE AND DOCUMENTS (COLLECTIVELY, "MATERIALS") TO YOU ONLY UPON THE CONDITION THAT YOU ACCEPT ALL OF THE TERMS CONTAINED IN THIS LICENSE AGREEMENT. BY USING THE MATERIALS, YOU ARE BINDING YOURSELF AND THE BUSINESS ENTITY THAT YOU REPRESENT (COLLECTIVELY, "CUSTOMER") TO THIS AGREEMENT. IF YOU DO NOT AGREE TO ALL OF THE TERMS OF THIS AGREEMENT, THEN LAUNCH IS UNWILLING TO LICENSE THE MATERIALS TO YOU AND DO NOT USE THE PRODUCTS AND DOWNLOAD OR INSTALL THE SOFTWARE.

The following terms of this End User License Agreement ("Agreement") govern Customer's access and use of the product, except to the extent there is a separate signed agreement between Customer and LAUNCH governing Customer's use.

License. Conditioned upon compliance with the terms and conditions of this Agreement, LAUNCH TECH. CO, LTC. or its subsidiary licensing the Materials instead of LAUNCH, grants to Customer a nonexclusive and nontransferable license to use for Customer's internal business purposes the Materials and the Document for which Customer has paid the required license fees. "Document"

means written information (whether contained in user or technical manuals, training materials, specifications or otherwise) specifically pertaining to the equipment and made available by LAUNCH with the equipment in any manner (including on CD-Rom, or on-line).

Unless otherwise expressly provided in the Document, Customer shall use the Software solely as embedded in, for execution on or (where the applicable document permits installation on non-LAUNCH equipment) for communication with LAUNCH equipment owned or leased by Customer and used for Customer's internal business purposes.

Note:

For evaluation or beta copies for which LAUNCH does not charge a license fee, the above requirement to pay license fees does not apply.

General Limitations. This is a license, not a transfer of title, to the materials, and LAUNCH retains ownership of all copies of the Materials. Customer acknowledges that the Materials contain trade secrets of LAUNCH, its suppliers or licensors, including but not limited to the specific internal designed structure of individual programs and associated interface information. Accordingly, except as otherwise expressly provided under this Agreement, Customer shall have no right and Customer specifically agrees not to:

(i) transfer, assign or sublicense its license rights to any other person or entity, or use the Materials on unauthorized or secondhand LAUNCH equipment, and Customer acknowledges that any attempted transfer, assignment, sublicense or use shall be void;

(ii) make error corrections to or otherwise modify or adapt the Materials or create derivative works based upon the Materials, or permit third parties to do the same;

(iii) reverse engineer or decompile, decrypt, disassemble or otherwise reduce the Materials to human-readable form, except to the extent otherwise expressly permitted under applicable law notwithstanding this restriction;

(iv) use or permit the Materials to be used to perform services for third parties, whether on a service bureau or time sharing basis or otherwise, without the express written authorization of LAUNCH;

(v) disclose, provide, or otherwise make available trade secrets contained within the Materials in any form to any third party without the prior written consent of LAUNCH. Customer shall implement reasonable security measures to protect such trade secrets.

To the extent required by law, and at Customer's written request, LAUNCH shall provide Customer with the interface information needed to achieve interoperability between the Materials and another independently created program, on payment of LAUNCH's applicable fee, if any. Customer shall observe strict obligations of confidentiality with respect to such information and shall use such information in compliance with any applicable terms and conditions upon which LAUNCH makes such information available.

Software, Upgrades and Additional Copies. For purposes of this Agreement, "Software" shall include (and the terms and conditions of this Agreement shall apply to) computer programs, including firmware, as provided to Customer by LAUNCH or an authorized LAUNCH reseller, and

any upgrades, updates, bug fixes or modified versions thereto (collectively, "Upgrades") or backup copies of the Software licensed or provided to Customer by LAUNCH or an authorized LAUNCH reseller.

NOTWITHSTANDING ANY OTHER PROVISION OF THIS AGREEMENT: (1) CUSTOMER HAS NO LICENSE OR RIGHT TO USE ANY ADDITIONAL COPIES OR UPGRADES UNLESS CUSTOMER, AT THE TIME OF ACQUIRING SUCH COPY OR UPGRADE, ALREADY HOLDS A VALID LICENSE TO THE ORIGINAL SOFTWARE AND HAS PAID THE APPLICABLE FEE FOR THE UPGRADE OR ADDITIONAL COPIES; (2) USE OF UPGRADES IS LIMITED TO LAUNCH EQUIPMENT FOR WHICH CUSTOMER IS THE ORIGINAL END USER PURCHASER OR LESSEE OR WHO OTHERWISE HOLDS A VALID LICENSE TO USE THE SOFTWARE WHICH IS BEING UPGRADED; AND (3) THE MAKING AND USE OF ADDITIONAL COPIES IS LIMITED TO NECESSARY BACKUP PURPOSES ONLY.

Proprietary Notices. Customer agrees to maintain and reproduce all copyright and other proprietary notices on all copies, in any form, of the Materials in the same form and manner that such copyright and other proprietary notices are included on the Materials. Except as expressly authorized in this Agreement, Customer shall not make any copies or duplicates of any Materials without the prior written permission of LAUNCH.

Term and Termination. This Agreement and the license granted herein shall remain effective until terminated. Customer may terminate this Agreement and the license at any time by destroying all copies of Materials and any Document. Customer's rights under this

Agreement will terminate immediately without notice from LAUNCH if Customer fails to comply with any provision of this Agreement. Upon termination, Customer shall destroy all copies of Software in its possession or control. All confidentiality obligations of Customer and all limitations of liability and disclaimers and restrictions of warranty shall survive termination of this Agreement.

Customer Records. Customer grants to LAUNCH and its independent accountants the right to examine Customer's books, records and accounts during Customer's normal business hours to verify compliance with this Agreement. In the event such audit discloses non-compliance with this Agreement, Customer shall promptly pay to LAUNCH the appropriate license fees, plus the reasonable cost of conducting the audit.

Export. Software, including technical data, may be subject to PRC. export control laws, including the PRC. Export Administration Act and its associated regulations, and may be subject to export or import.

Table of Contents

Introduction	1	Using the Soft Keyboard.....	21
Features	1	Input by Keyboard.....	21
Precaution on Operation.....	1	Input by Writing Board	21
Maintenance.....	1	Control of App	22
Storage.....	1	Check Box	22
Take Care of the Screen	1	Scrolling Bar	22
Maintenance of CF card.....	2	Common Button.....	22
Outline of X431 Heavy-duty.....	2	Help	22
Ports	2	Tools and Game.....	23
Hardware Configuration.....	3	Tools	23
Printer Operation	3	Game.....	25
Mounting Paper.....	3	PIM.....	26
Specifications	4	Memo.....	26
Vehicle Diagnosis.....	5	Address.....	28
Button Descriptions	5	To Do	29
Conditions for Test.....	5	Schedule.....	31
Select Diagnostic connector	5	System	34
Diagnostic Socket Location	5	Control Panel	34
Connection	5	System Information.....	37
Operation.....	6	Shut Down	38
Entering Function Menu	6	FAQ	39
Control Unit Version	9	About Update via Internet	39
Read Fault Memory.....	9	About Hardware	40
Clear Fault Memory.....	9	About System Setting	41
Actual Value Indicator	10	About Operation.....	42
Update of Diagnostic Software	13	Questions Related to Vehicle.....	43
Hardware Requirement	13		
User Registration.....	13		
Fill in Product Information	13		
Fill User Information	14		
Software Update.....	14		
Member Login	14		
Software Download	15		
Software Purchase and Update	16		
Flow Chart of X431 heavy-duty Update for New User.....	18		
Main Unit.....	19		
Introduction.....	19		
Interface	19		
Input	21		

Introduction

X-431 heavy-duty automobile diagnostic platform(X431 heavy-duty for short) is a newly developed automobile diagnostic computer. Including all the advantages of its predecessor, X431 heavy-duty is designed to cover diesel and gas-fueled vehicle models of 12V&24V voltage.

It featured ergonomic design, compact structure, convenient use and strong expandability.

Features

- No need for battery conversion when testing 24V trucks.
- Support all the current X-431 software.
- Fast upgrading via the internet to keep up with the latest vehicle models.
- International design to adapt to all diagnostic sockets.
- Including all the electronic control system.
- Unique data transfer to ensure fast operation.
- Connection with PC to keep service records through optional X431 PCCENTER.
- Large compact flash memory for data storage.
- CAN diagnostic adaptor for CANBUS models.

Precaution on Operation

- Do not insert and pull out CF card too frequently. Press ejector button before pulling out the CF card. Insert the CF card into the CF card slot, **keep the face labeled "UPSIDE" upward**, and make sure the card is fully seated.
- Handle with care. Avoid hitting. Unplug the power after operation.
- Put the stylus into the hole of X-431 heavy-duty handle after operation. And put

the cables, connectors and other accessories into box.

- Hold the connector when plug or unplug it. Do not pull the cable for unplugging.

Maintenance

Storage

- Store the X431 heavy-duty on a flat and dry place with suitable temperature.
- Never put the X431 heavy-duty in direct sunlight or near the heating source.
- Prevent smoke, water and oil from entering the X431 heavy-duty.
- Avoid shock, dust, moisture and extremely high temperature.
- Do not disassemble the main unit. Clean the outside surface and screen with soft cloth that is dipped with a little water if the main unit is dirty. This should be done after the machine is turned off and the power cable is removed.
- Periodically turn on the X431 heavy-duty main unit if it is not operated for long time to avoid moisture.

Take Care of the Screen

- Turn off the power if it is expected not to operate the X431 heavy-duty for a long while. It can extend the life of screen and save energy.
- Do not put anything on the main unit to avoid damage to the internal parts.
- Use the equipped stylus to click the screen. Do not use fingernail or other sharp object to touch the screen.
- Dust may be accumulated on the LCD screen owing to electrostatic. It is suggested to buy the special LCD screen wiper to clean the screen gently. Do not

wipe the screen with bare finger.

- Never use chemicals to clean the screen.

Maintenance of CF card

- Do not pull out the CF card when the X431 heavy-duty main unit is working.
- Pull out the CF card and store it in the place without magnetic field after the machine is turned off. Do not turn on/off the X431 heavy-duty main unit too frequently.
- CF card reader/writer may be used when doing updating. The CF card must not be pulled out when the CF card reader/writer is being used. Otherwise, the data in the CF card will be lost. Procedure for pulling out the CF card is as follows:

On the desktop of Windows, open the window of "My computer". Click the right mouse button on "Removable disk" to pop up a menu. Select "Ejector (J)" in the menu. Then pull out the CF card. The written data may be lost if the CF card is pulled out discretionarily. When you want to use the CF card again, put it in.

- In case X431 heavy-duty CF card is damaged and the program in the card can not be used, please use the following procedure to remake the CF card:

- ✧ Log onto the website "www.X431.com". Enter your username and password to log in. Select the SMARTBOX No., and then download the X431 heavy-duty UPDATE TOOLS, DISPLAY PROGRAM, SYSTEM DATA and necessary diagnostic program into your computer.
- ✧ Install the X431 heavy-duty UPDATE TOOLS into computer.
- ✧ Format the X431 heavy-duty CF card.

- ✧ Run the X431 heavy-duty UPDATE TOOLS and write the display program, system data and diagnostic programs onto CF card.

Outline of X431 Heavy-duty



Figure 1-01

Figure 1-01 shows the outline of X431 heavy-duty.

Additional parts, such as main cable, power cable, power adapter, CF card, CF card reader/writer, diagnostic connectors and so on, are equipped for vehicle diagnosis.

Ports

See Figure 1-02 for X431 heavy-duty connection ports.



Figure 1-02

Hardware Configuration

For vehicle diagnosis, some accessories (e.g. connectors and cables) should be used to connect the X431 heavy-duty main parts to the vehicle diagnostic socket.

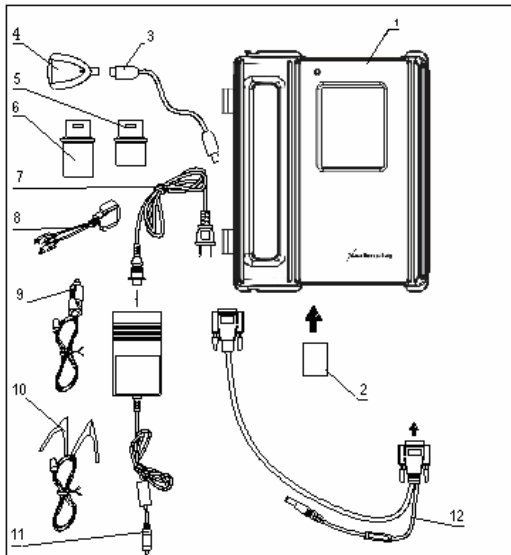

Figure 1-03

X431 heavy-duty configuration is as shown in Figure 1-03.

No.	Name	Description
1	X431 Heavy-duty Main Unit	The screen of main unit can display the operation buttons, the test result and the help information.
2	CF card	Store diagnostic software and data
3	USB cable	Connect CF card reader and computer
4	CF card reader	Read or write data from/to the CF card
5	Diagnostic connector	Dozens of connectors are provided/available for various vehicles. Here shows a typical one.
6	CAN BUS diagnostic connector	Test CAN BUS system.
7	Power cord	Connect the AC

		100-240V (50-60Hz) outlet and the power adapter.
8	Diagnostic connector with cable	Connect the vehicle diagnostic socket
9	Cigarette lighter cable	Get power from the vehicle cigarette lighter
10	Battery cable w/two clips	Get power from the vehicle battery
11	Power adapter	Convert 100-240V AC power into 12V DC power.
12	Main cable	To connect the diagnostic connector and X431 heavy-duty main unit

Printer Operation

Figure 1-04 shows the back view of the X-431 heavy-duty.

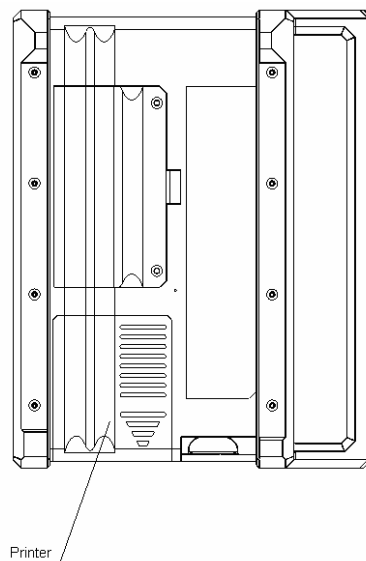

Figure 1-04

Mounting Paper

Miniprinter uses thermal paper with size of Φ 30 × 57mm (internal hole Φ 7mm). Refer to Figure 1-05 for mounting the paper.

1. Open the housing of main unit and get out main unit.
2. Open the paper lid on the back of the printer. See Figure 1-05a.



Figure 1-05a

3. Take out the spindle and mount the paper scroll onto the spindle. Put the paper spindle into the printer with correct direction. The paper may not be fed if the direction is wrong. See Figure 1-05b.



Figure 1-05b

4. Open the side plate, pull up the pressing rod and lead the paper into slot. See Figure 1-05c. Turn the feed knob clockwise until the paper comes out of the outlet. See Figure 1-05d.



Figure 1-05c



Figure 1-05d

5. Adjust the paper and attach the paper lid.
6. Put main unit into housing.

Specifications

- Operating system: LINUX
- CF card: 512M
- Main unit I/O: standard serial/parallel port
- Main unit power source: DC12V
- Main unit power: about 5W
- Printer: high-speed thermal mini printer
- Screen: 240*320 LCD touch screen with back light

Vehicle Diagnosis

Button Descriptions

The main buttons on the operation interface and their functions are as follows:

- [BACK]: to return to the previous interface.
- [START]: to do the next operation.
- [EXIT]: to exit the diagnostic program.
- [OK]: to confirm and execute.
- [CANCEL]: to cancel present operation and return to the previous interface.
- [PAGE UP]: to display the previous page. It is inactive if the current page is the first page.
- [PAGE DOWN]: to display the next page. It is inactive if the current page is the last page.
- [HOME]: return to the main interface.
- [BOX INFO]: to show the version information of SMARTBOX.
- [HELP]: to display the help information.
- [RETRY]: to do the unfinished operation once again.

Conditions for Test

- Turn on the key.
- The rated voltage of the X431 heavy-duty is 12V. The voltage of vehicle battery may be 12V or 24V.
- The throttle should be in the closed position.
- X431 heavy-duty can be operated in the temperature of 0-50°C. (30 minutes of warming-up may be necessary when the ambient temperature is 5°C).

Select Diagnostic connector

Various diagnostic connectors are supplied with X-431 heavy-duty. Select a specific connector according to the tested vehicle.

Let's take Benz heavy-duty vehicle (Benz HD for short) as example to describe the test procedure.

Note:

The test procedure for different vehicle make is similar. Please refer to the

described procedure and the screen prompts when diagnosing other vehicle.

Benz HD is usually equipped with 14PIN or 16PIN diagnostic socket.

Diagnostic Socket Location

The location of different model will be different. For details, please refer to Service Manual.

Connection

- Insert the CF card into the CF card slot, **keep the face labeled "UPSIDE" upward, and make sure the card is fully seated.**
- Insert one end of the main cable into the diagnostic socket on SMARTBOX.
- Connect the other end of the main cable to one end of OBD6&9 adaptor.
- Connect the other end of OBD6&9 adaptor to diagnostic connector.
- Connect the other end of the diagnostic connector to the vehicle diagnostic socket. See Figure 2-01.

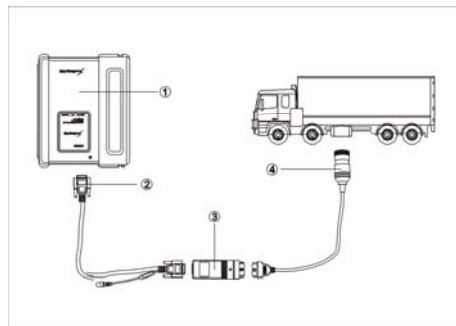

Figure 2-01

- ①-X431 heavy-duty ②-Diagnostic main cable
- ③-OBD6&9 adaptor ④-Diagnostic connector

Note:

If the power supply on vehicle diagnostic socket is insufficient or the power pin is damaged, you can get power in the following ways:

- ◆ *From cigarette lighter: insert one end of the cigarette lighter cable into the*

lighter socket in vehicle and connect the other end to the power connector of X431 heavy-duty main cable.

- ◆ From battery: clamp the two clips of battery cable on the positive and negative poles of battery and insert another end of the cable into the power connector of X431 heavy-duty main cable.
- ◆ From power adapter: connect the power adapter to the 100-240V AC outlet with power cord. Insert the 12V DC plug of power adapter into the power connector of X431 heavy-duty main cable

- ◆ [BOX INFO.]: to display hardware and software version of SMARTBOX.
- ◆ [HELP]: to display help information.
- ◆ [START]: to start the diagnosis.

Click [START] button, the screen will display the vehicle make menu as shown in Figure 2-03.

Operation

Entering Function Menu

After connection, press [POWER] key to start X431 heavy-duty.

After starting the main unit, press [HOTKEY] (or click [Start] button on the main menu, and select [GAG]→[GD Scan] on the pop-up menu), the screen will display the home page of vehicle diagnosis as shown in Figure 2-02.



Figure 2-02

Button descriptions:

- ◆ [QUIT]: to exit the diagnostic program.

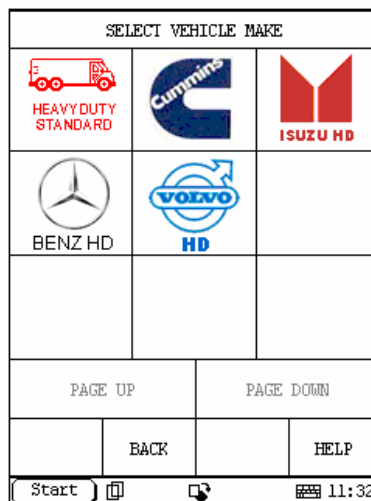

Figure 2-03

Button descriptions:

- ◆ [BACK]: to return to the previous interface.
- ◆ [PAGE UP]: to display the previous page, it is inactive if the current page is the first page.
- ◆ [PAGE DOWN]: to display the next page, it is inactive if the current page is the last page.
- ◆ [HELP]: to display the help information.

Click the icon of Benz HD on the vehicle make menu. The screen will be displayed as shown in Figure 2-04.

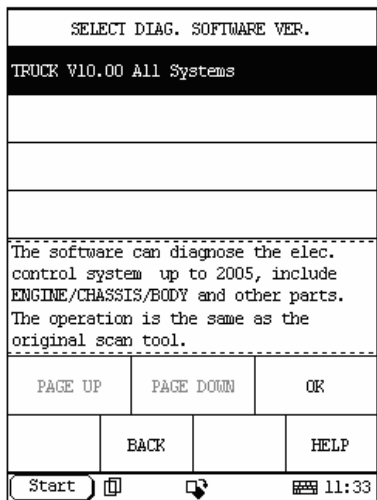

Figure 2-04

Button descriptions:

- ◆ **[BACK]:** to return to the previous interface.
- ◆ **[HELP]:** to display the help information.

Click [Truck V10.00 All Systems]. X431 heavy-duty begins reset and check the SMARTBOX, and download the diagnostic program from the CF cartridge. After download, the screen will be displayed as shown in Figure 2-05.

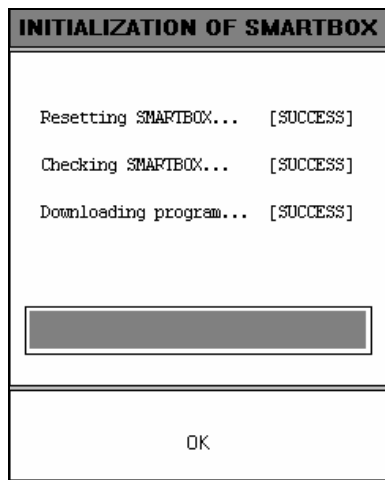

Figure 2-05

Button descriptions:

[OK]: to go on the test.

Click [OK]. The display will be as shown in

Figure 2-06.

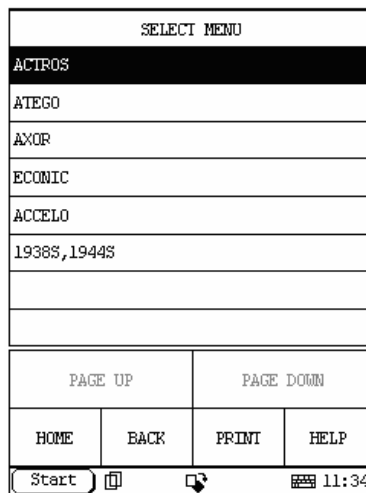

Figure 2-06

Click [ACTROS]. The display will be as shown in Figure 2-07.

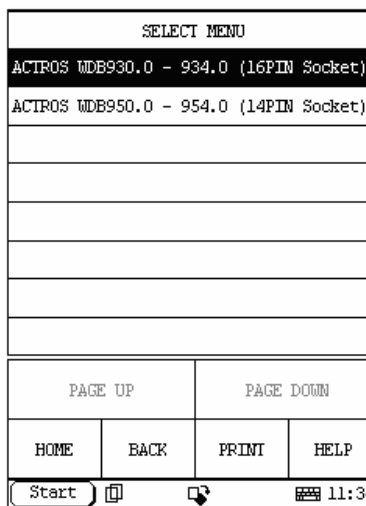

Figure 2-07

The software can diagnose the electronic control systems of Benz HD up to 2005. The operation is the same as that of the original scan tool.

After selecting correct model, the screen displays the menu of test systems as shown in Figure 2-08

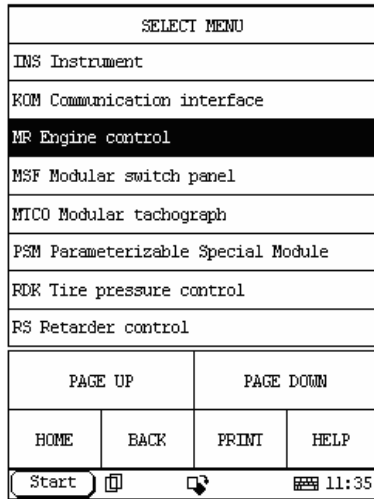

Figure 2-08

There are several pages for the menu. Click [PAGE DOWN] to see the next page.

Button descriptions:

- ◆ [PAGE DOWN]: to display the next page.
- ◆ [HOME]: to return to the homepage of vehicle diagnosis.
- ◆ [BACK]: to return to the previous interface.
- ◆ [HELP]: to display the help information.

Click [MR Engine control]. If the communication is successful, the screen will display the menu as shown in Figure 2-09.

Note:

The test operation for different systems is similar. Here we take [Engine electronics] as an example to describe.

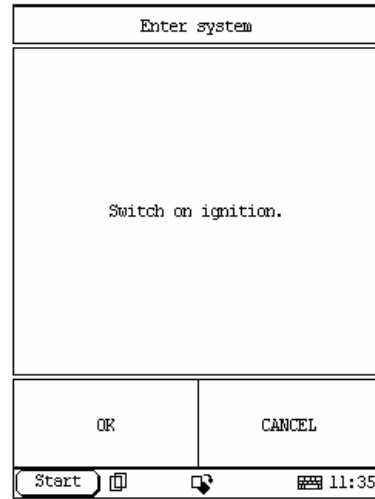

Figure 2-09

Button descriptions:

- ◆ [OK]: to go on the test.

Click [OK] button. The screen will display the function menu as shown in Figure 2-10.

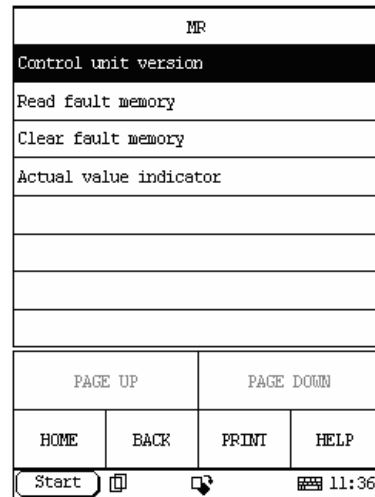

Figure 2-10

Button descriptions:

- ◆ [HOME]: to return to the homepage of vehicle diagnosis.
- ◆ [BACK]: to return to the previous interface.
- ◆ [HELP]: to display the help information.
- ◆ [PAGE DOWN]: to display the next page.

Control Unit Version

Click [Control Unit Version] in the function menu. The screen will display the information on ECU of the tested system. See Figure 2-11.

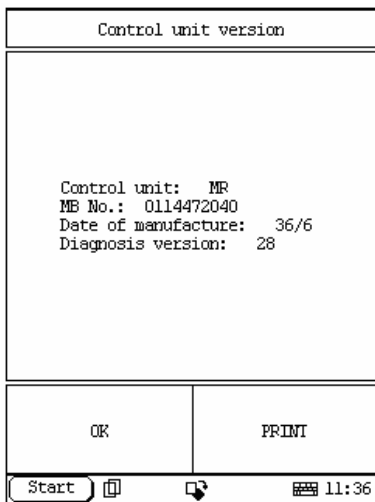

Figure 2-11

Note:

The information is from the vehicle ECU. If you have any question during test, don't hesitate to contact LAUNCH to get answer as soon as possible.

Click [OK] button to return to the function menu.

Read Fault Memory

Click [Read Fault Memory] in the function menu. X431 heavy-duty starts to test the fault code. The screen will display the test result when the test is finished. Figure 2-12 is an example of a test.

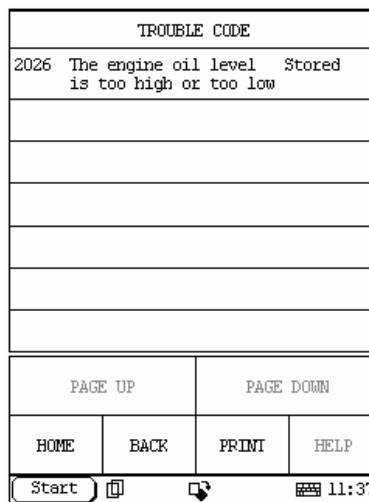

Figure 2-12

Button descriptions:

- ◆ [HOME]: to return to the homepage of vehicle diagnosis.
- ◆ [BACK]: to return to the previous interface.

If there is no fault code in the tested system, the display will be as shown in Figure 2-13.

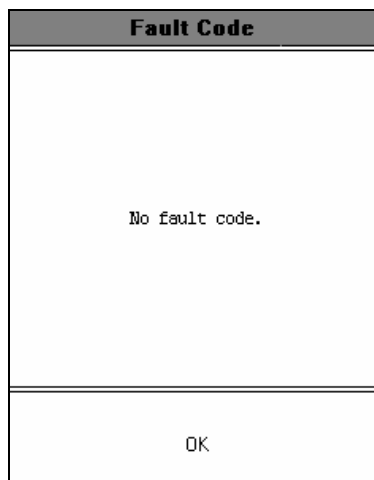

Figure 2-13

Click [OK] button to return to the function menu.

Clear Fault Memory

Click [Clear Fault Memory] in the function menu. X431 heavy-duty starts to erase the

fault code. See Figure 2-14.

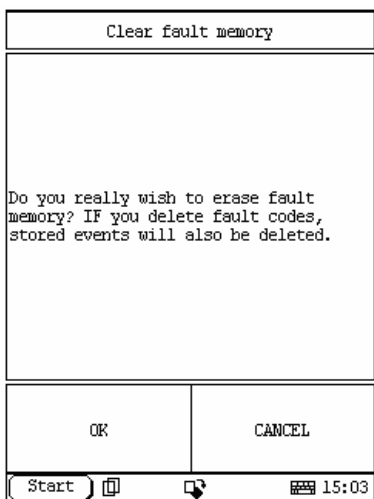

Figure 2-14

Button descriptions:

- ◆ **[HOME]:** to return to the homepage of vehicle diagnosis.
- ◆ **[BACK]:** to return to the previous interface.

If all fault codes are erased or there is no fault code in the tested system, the screen will be displayed as shown in Figure 2-15.

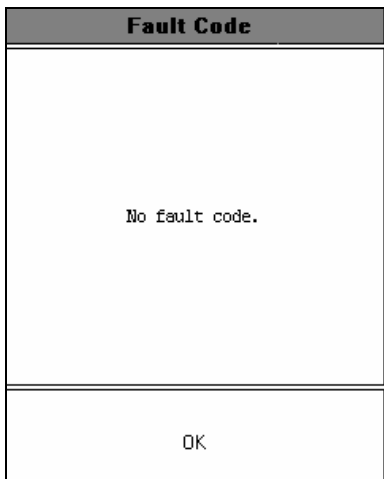

Figure 2-15

Click [OK] button to return to the function menu.

Actual Value Indicator

Click [Actual Value Indicator] in the function menu. The screen will display the information as shown in Figure 2-16.

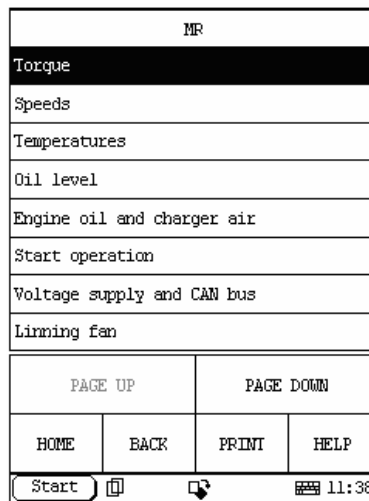

Figure 2-16

Click the corresponding data stream items.

Button descriptions:

- ◆ **[PAGE DOWN]:** to display the next page.
- ◆ **[HOME]:** to return to the homepage of vehicle diagnosis.
- ◆ **[BACK]:** to return to the previous interface.
- ◆ **[HELP]:** to display the help information.

The screen will display the information as shown in Figure 2-17.

DATA STREAM	
001 Actual engine torque	845 Nm
002 Specified engine torque	2000 Nm
003 Maximum momentary engine torque	1640 Nm
044 Torque limit as a result of engine protection	NOT ACTIVE
045 Torque limit as a result of full load	NOT ACTIVE
046 Torque limit as a result of maximum speed governing	NOT ACTIVE

PAGE UP	PAGE DOWN	SAVE	GRAPHIC-1
HOME	BACK	PRINT	HELP

Start [F1] [F2] 11:39

Figure 2-17

Click [GRAPHIC-1] in Figure 2-17, the screen will display the wave form of the first data item. Click [PAGE DOWN], it will display wave form of next data item. See Figure 2-18.

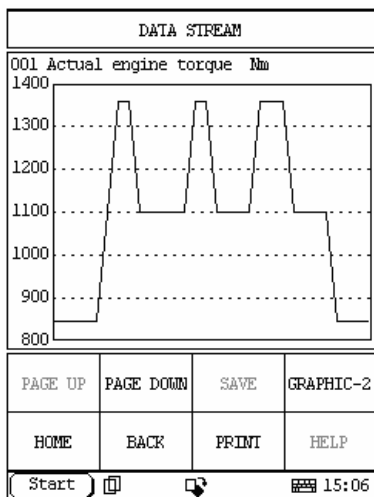

Figure 2-18

Click [GRAPHIC-2] to display the waveforms of 2 data stream items. It is convenient for users to make live comparison between two correlative data stream items.

Note:

- ◆ The two display modes -- [GRAPHIC-1] and [GRAPHIC-2] can be switched.

Record Data Stream

- Record data stream function is mainly used for:
- Recording and saving the data under normal driving status as the standard value for reference;
 - Snapping and recording pending trouble codes for analysis.

If you want to record the selected data stream, please click [SAVE] in Figure 2-17. The screen will display the menu as shown in Figure 2-19.

STREAM SAVE		
SAVE		
DISPLAY		
CLEAR		
HOME	BACK	HELP

Start [F1] [F2] 07:21

Figure 2-19

Note: the SAVE in Figure 2-17 is actually the menu. Only enter this menu, can you save, display and clear data

Click [SAVE] to enter the interface as shown in Figure 2-20. Now it starts to record data stream. Click [STOP] to terminate the record. And the recorded data stream will be saved into the save folder in the CF card.

The data in the CF card can be uploaded to PC or service department of Launch and the recorded data stream can be analyzed.

DATA STREAM	
001 Actual engine torque	845 Nm
002 Specified engine torque	2000 Nm
003 Maximum momentary engine torque	1640 Nm
044 Torque limit as a result of engine protection	NOT ACTIVE
045 Torque limit as a result of full load	NOT ACTIVE
046 Torque limit as a result of maximum speed governing	NOT ACTIVE
PAGE UP	PAGE DOWN
STOP	GRAPHIC-1
HOME	BACK
PRINT	HELP
Start 07:21	

Figure 2-20

Note: the name of the file can be automatically generated.

Download DEMO program from www.x431.com to your X431 HEAVY-DUTY, power X431 HEAVY-DUTY through DC, and start the DEMO program to enter the interface as shown in the Figure 2-19.

Click DISPLAY and the screen will display the recorded file as shown in Figure 2-21. The name of file is composed of software name, record date and record time.

STREAM DISPLAY			
20060706	2006.7.6	15:32:05	
20060707	2006.7.7	11:05:12	
20060710	2006.7.10	15:27:12	
PAGE UP	PAGE DOWN	DELETE	DISPLAY
HOME	BACK	HELP	
Start 07:22			

Figure 2-21

Note: if there is more than one page in the file, you can click PAGE DOWN to view.

Choose one recorded file, and click DISPLAY to enter the interface as shown in Figure 2-22. You can click [->] or [->] to view the previous frame or the latter frame.

DATA STREAM			
001 Actual engine torque	845 Nm		
002 Specified engine torque	2000 Nm		
003 Maximum momentary engine torque	1640 Nm		
044 Torque limit as a result of engine protection	NOT ACTIVE		
045 Torque limit as a result of full load	NOT ACTIVE		
046 Torque limit as a result of maximum speed governing	NOT ACTIVE		
PAGE UP	PAGE DOWN	<-	->
HOME	BACK	HELP	
Start 07:23			

Figure 2-22

Update of Diagnostic Software

The Internet update function of X431 heavy-duty provides user with a convenient and quick way to download the software from our website for update.

LAUNCH put the latest version of software to www.X431.com and display the message on the news page. User can use computer to visit the Website in any part of the world. After registration, the latest version of software can be downloaded. Then user can update his X431 heavy-duty by unzipping and installing the software.

Hardware Requirement

Necessary hardware:

1. A computer that can access the Internet.
2. A CF card reader/writer and a CF card that need to be updated.

See Figure 3-01 for hardware connection.

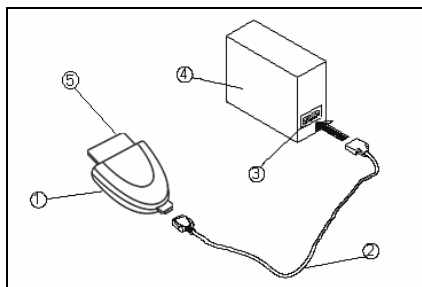

Figure 3-01

- | | |
|-------------------------|-------------|
| 1-CF card reader/writer | 2-USB cable |
| 3-USB Port | 4-Computer |
| | 5-CF card |

- Insert the CF card into the CF card reader/writer.
- Connect one end of the USB cable② to the port of the CF card reader/writer①, and the other end to the USB port of the computer.

User Registration

Log on www.X431.com. Select the favorite language on the pull-down menu at the upper left of the interface to enter the homepage. See Figure 3-02.



Figure 3-02

Click "Register" in the interface as shown in Figure 3-02 to open the window as shown in Figure 3-03.

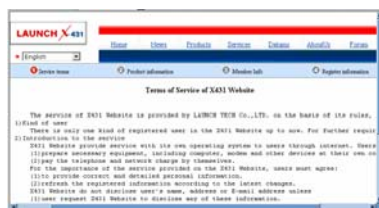

Figure 3-03

Note:

When the member purchases one or more products after registration, he should log onto the member area, and then click "product control" to register the newly purchased product. Refer to the section "Member login".

The terms of service is shown in the screen. After reading and fully understand it, click "I accept" button to enter the interface as shown in Figure 3-04.

Fill in Product Information

Fill in the serial No. of X431 heavy-duty smartbox, registration No. and dealer code in the interface as shown in Figure 3-04.



Figure 3-04

The serial No. is marked on the back of smartbox. The registration No. is in an envelope delivered with the product (the number must be kept confidential). The dealer code is attached on the last page of the user's manual.

After the information is filled, click "Next step" to enter the next interface as shown in Figure 3-05.

Note:

1. When a product is sold, the dealer will log onto www.X431.com and enter the dealer code in the "Dealer administration" area so that the user can do effective registration later. User should contact the dealer if registration can not be done effectively.
2. If the filled serial No. or registration No. is invalid, the screen will display the message as shown in Figure below. Click "OK" button to return to the previous interface to re-fill the correct numbers.



Fill User Information

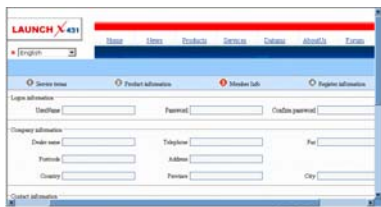

Figure 3-05

After information is filled in the interface shown in Figure 3-05(The red textbox must be filled). After registration, we will send the confidential information to your registered e-mail, so please make sure that your e-mail is valid.), click "Next step", and then the screen will display the interface shown as Figure 3-06. Click "OK" then the registration is completed.



Figure 3-06

Note:

Only the registered user can download and update the software.

Software Update

Member Login

The user becomes the registered member after registration. Member can log in the website by filling username, password and user type in the interface as shown in Figure 3-02.

Note: when choosing the user type, the common users may choose the customer. If the dealer and the branch want to log in the website, please use the user information given by LAUNCH head office.

After log successfully, the screen will display the interface as shown in Figure 3-07(The default interface is download center interface).



Figure 3-07

[Download Center]: Refer to "software download".

[Purchase Center]& [Update center]: Refer to "software purchase and update".

[Member Information]: Display and renew the current member information.

[Product Registration]: Register newly purchased product.

[Order Information]: Check or cancel the unpaid order.

[Renew Password]: After entering the right old password, then can renew the password.

[Awarded for complaint] If users meet some trouble during the operation, he can feedback to LAUNCH. Effective complaint will be awarded by LAUNCH

[Logout]: Users exit the registration.

Software Download

After log successfully, the screen will enter the [download center] interface. (See Figure 3-07) Registered user can download the software that installed in the download center.

Before download, users had better set up a new folder named [X431 heavy-duty update] on the computer desktop and put the download file to the[X431 heavy-duty update] according the next steps.

Note:

1. *Software update of free charge will be provided by LAUNCH for one year. The free period is from the registration date on the website, not the purchase date. That is, during one year after the registration, users can free download the corresponding software.*
2. *If there is not the latest version in the download center, users can buy the version in the purchase center or in the update center. In the*

purchase center, users can buy the software that doesn't install in the download center. In the update center, users can buy the software that is beyond the free download period. After purchase successfully, the purchased software will be automatically added to the download center list.

Update Tool Download

Before update, users must download the update tools. On the drop-down menu, users select the language then click [download]. The screen will display the interface as shown in Figure 3-08.



Figure 3-08

Click [save] to put it into the[X431 heavy-duty update].

Display Program Download

When downloading the diagnostic program, users can also download the display program. On the drop-down menu, users select the language then click [down].Click [save] on the pop-up menu to put the program into the[X431 heavy-duty update].

Diagnostic Program Download

On the drop-down menu, select the language and the version (The default version is the latest version). Click [down] icon, then click [save] on the pop-up menu to save the file.

Click [view] to learn the detailed information of the version.

Users can download the diagnostic program into the [X431 heavy-duty update]. Up to now, the software that is for update is downloaded completely.



Figure 3-09

Select the module for update in the interface shown in Figure 3-10, and click "Update" icon to update. When the update is completed, prompts will appear to notify successful update.

Software Purchase and Update

If users can't find the software that he needed, at this time users should buy the software in the purchase center. Log on the www.X431.com then enter the interface as shown in Figure 3-11.



Figure 3-11

Software Update

Open the "X431 heavy-duty update" folder, and double click the icon . Then install the update tool according to the prompts on the screen.

When the installation is complete, the "X431 heavy-duty update tool" icon will appear on the desktop.

Double click the "X431 heavy-duty update tool" icon to run the program. The program will automatically check the downloaded update files, including the diagnostic program and the display program. See Figure 3-10



Figure 3-10

Click [purchase center] to choose serial number, and then tick in front of software number.

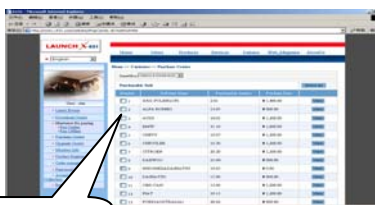

Tick here.

Figure 4-16

Take AUDI as an example, click [view] behind AUDI, and the screen will display the detailed information about the AUDI diagnostic software.



Figure 4-17

Click [order] to add the selected software to

shopping cart. See Figure 4-17.

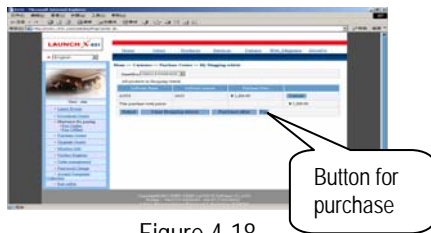

Figure 4-18

Click [pay] to buy the software. The bought software will be automatically added to the user's download center.

Click [clear] to clear all the software in the shopping cart.

Click [purchase other] to buy other software. See Figure 4-18

Note:

The operation for update center is the same as that for the purchase center.

Flow Chart of X431 heavy-duty Update for New User

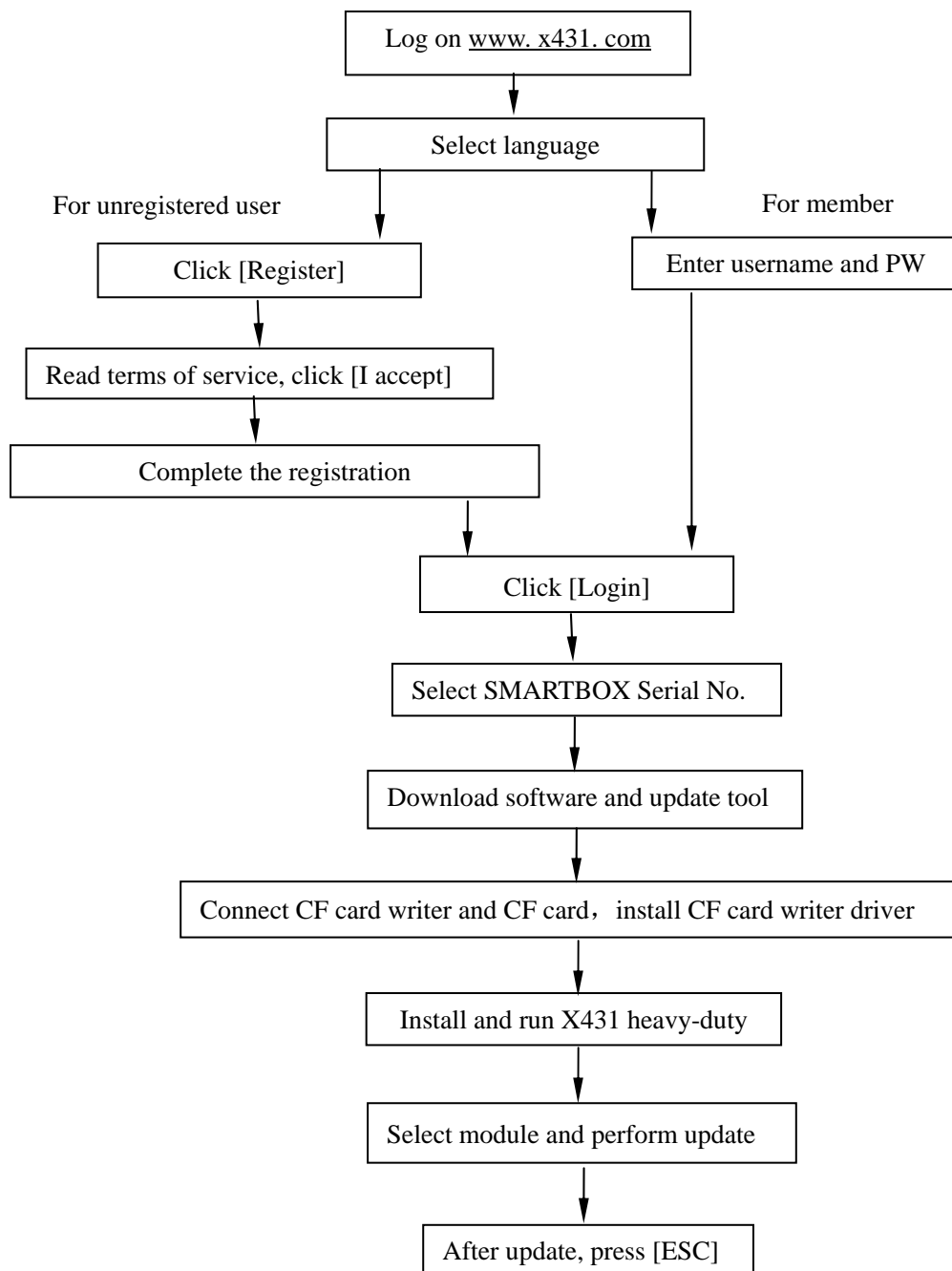

Main Unit

Introduction

Interface

Turn on the power source, and then press [Power] key on the machine. The screen will display the prompts about touch screen calibration. Press [Hot] key (refer to the section "Calibrate Touch screen" for detailed steps) if you want to make calibration, otherwise, you can wait until it displays the start interface as shown in Figure 4-01.



Figure 4-01

Note:

An interface for User Register will be displayed when the machine is started at first time. Refer to the section "User Register" for detailed steps.

When you want to turn off the machine, press and hold [Power] key for at least 2 seconds.

[Start] button: Its function is the same as that in Windows. Click it to pop up the start menu. The items and their respective functions in the menu are shown in the following table.

[Active Taskbar Icon] Active Taskbar Icon: Click it by stylus to display and switch the executed programs.

[Overturn Icon] Overturn Icon: Click it by stylus to overturn the menu at 180 degrees

[Soft Keyboard Icon] Soft Keyboard Icon: Click it to activate the soft keyboard. Then you have two ways to choose:

1. Input by soft keyboard;
2. Input by writing board.

Functions:

PIM (Personal Information Management)	Memo	To record all kinds of important information and ideas, and make corresponding classification.
	Address	To store the detailed information of relative, friends, colleagues and business partners, which can be easily edited, retrieved and searched.
	To Do	It is convenient for user to record the business to do or being done, to delete or add task records, to arrange the priority of tasks, and to browse the classified tasks.

	Schedule	To arrange the appointments, journeys and meetings in a whole day; to check time schedule on business daily, weekly, monthly and/or annually; and to describe the place, time and other details for each schedule record.
Tools	Calculator	Both simple and scientific calculators are available.
	World Time	The time of many big cities in the world are offered. It is a helpful assistant for your travel.
	Mini Dictionary	An English-Chinese dictionary embodies a large number of words, which cover all fields to overcome your inconvenience in language.
	Picture View	To enjoy all kinds of pictures which can be zoomed in/out.
	Run	To start executable applications which are based on the operating system of the unit.
Game	FIR	It is a kind of chess.
	Reversi	To play for a while in your leisure time.
Control Panel	Application	To link the application with the 'Start' menu, or delete it from the 'Start' menu.
	Power Management	To preset the use of power to save on electricity as possible.
	Clock Set	To set the system time.
	Contrast	To adjust the contrast of display.
	Language Set	To select language to be used.
Vehicle maintenance	Vehicle diagnosis	Professional function of vehicle diagnosis.
	Sensor test and simulation	To test the sensor on vehicle and simulate the output signal from the sensor.

Input

Note: To input data, please activate Soft Keyboard with stylus and use the stylus in the subsequent operations.

Using the Soft Keyboard

Activate and Hide

You can click Soft Keyboard icon on the bottom of the touch screen to activate the soft keyboard, and click again to hide it.

Input by Soft Keyboard

You have two ways to choose. One is to input by Soft Keyboard just like normal keyboard, but with stylus instead of finger. The other is to input by writing board.

Click [En] button, it will switch from normal keyboard to writing board [Hw]. And click [Hw] button, it will switch back.

The Function Key

There are four function keys on the upper-right of the Soft Keyboard. SBC/DBC case, punctuations, Keyboard/Writing board, and the Soft Keyboard position can be determined by clicking one of the four keys for each of the functions from left to right. (Refer to Figure 4-02)

The four function keys at the upper-middle position are for moving the cursor leftward, rightward, upward or downward.



Figure 4-02

In keyboard mode, the key at the bottom left of the keyboard is [Shift] key. Click it to change the lowercase letter into the uppercase letter, and the numeral key into special symbol (same as the special characters corresponding to the numeral keys in normal keyboard). The white

key at the bottom right of the Soft Keyboard is space key.

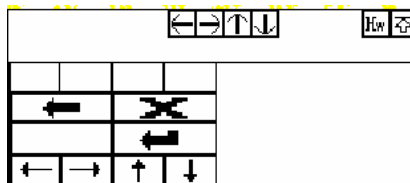

Figure 4-03

In writing board mode (refer to Figure 4-03), there are eight function keys at the lower left of the soft keyboard. The four ones on the bottom implement the function: to move the cursor leftward, rightward, upward or downward. The other four functions are (from left to right): to delete the first character before the current cursor, clear the hand-writing section, space and return.

Input by Keyboard

- 1) Open an interface, such as User information.
- 2) Click Soft Keyboard Icon in the tool bar to activate Soft Keyboard.
- 3) Click the characters on Soft Keyboard to enter data. (Refer to Figure 4-04)

Input by Writing Board

- 1) Open an interface, such as Memo.
- 2) Click [New] button.
- 3) Click the function key to switch to Writing Board. (Refer to the section "Use for Soft Keyboard").
- 4) Write on the white board to the right of the Soft Keyboard. Enter the information by function key operation.

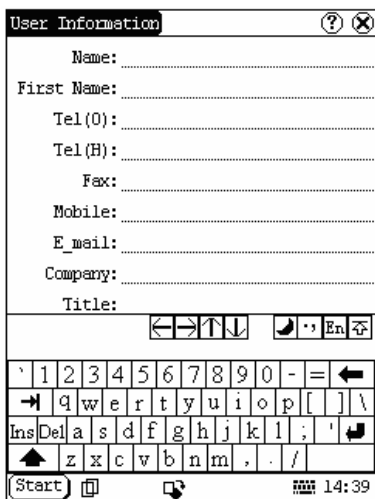

Figure 4-04

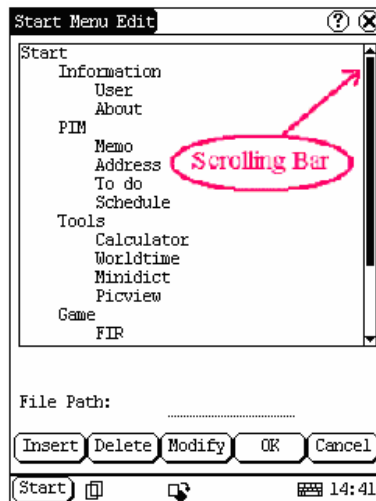

Figure 4-06

Control of App

Check Box

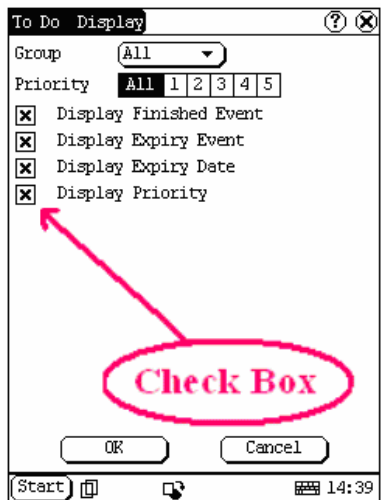

Figure 4-05

Click the check box to select the function. When the function is selected, 'X' will be marked in the check box and the function description will be displayed on the right of the check box. You can select several functions at the same time. (Refer to Figure 4-05)

Scrolling Bar

Scrolling Bar is usually at the right side of the touch screen. You can click or drag it to operate. If the content can't be displayed completely in one page, moving the Scrolling Bar can turn to next page. (Refer to Figure 4-06)

Common Button

[X] Button at top right corner of the interface: After clicking it, current interface will be closed. When editing is being done, clicking of the button will be treated as quitting the editing.

[?] Button at top right corner of the interface: After clicking it, the help information will be shown.

[Cancel] Button in the interface: After clicking it, current interface will be closed.

Help

Click [?] button at the top right corner of the interface to get helpful tips for current interface.

Tools and Game

Tools

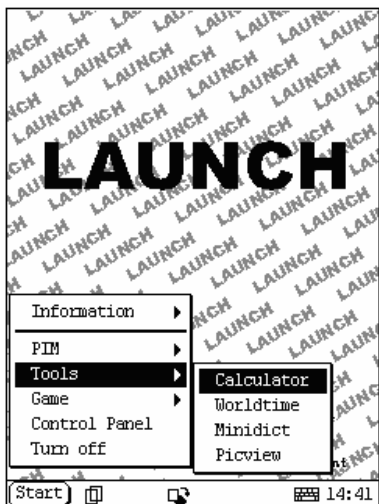

Figure 4-07

- 1) Click [Start] button.
- 2) Select 'Tools' in the pop-up menu.
- 3) Select the function needed in the pop-up submenu. (Refer to Figure 4-07)

Calculator

This calculator can perform not only common calculations as a simple calculator, such as addition and subtraction, but also the function operations as a scientific calculator, such as logarithm and factorial. (Refer to Figure 4-09).

- 1) In the pop-up menu of 'Tools', select 'Calculator' to open the Calculator interface.
- 2) Click the square overlap icon on upper left of the screen to switch between scientific calculator and simple calculator.
- 3) Click 'Unit Conversion' button to switch between unit conversion calculator and simple calculator.

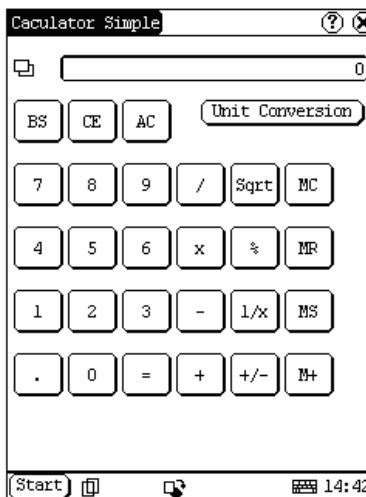

Figure 4-08

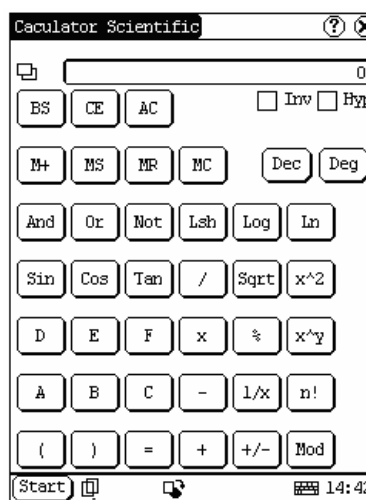

Figure 4-09

Common Calculator (Refer to Figure 4-08):

- 1) Click numeral keys on the screen to input.
- 2) Or activate Soft Keyboard, and click numeral key on Soft Keyboard to input.
- 3) The operation is the same as that for normal calculator.

Unit Conversion Calculator (Refer to Figure 4-10):

- 1) Click 'Unit type' button at the top right corner to select unit type.
- 2) Input the number to be converted in the blank next to the unit name, and then you will see the conversion result.

- 3) If you want to return to simple calculator, please click 'X' button at the top right corner to close the current interface.

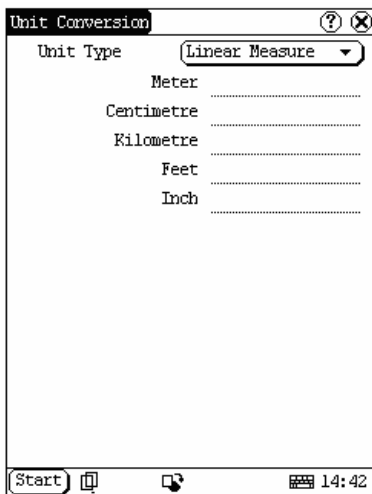

Figure 4-10

Dictionary

- 1) In the pop-up menu of 'Tools', select 'Dictionary' to open the Dictionary interface. (See Figure 4-12)
- 2) Activate Soft Keyboard, and input words.
- 3) Select the word from the list on the left.
- 4) Click the word, and then you can find the translation in the right list.

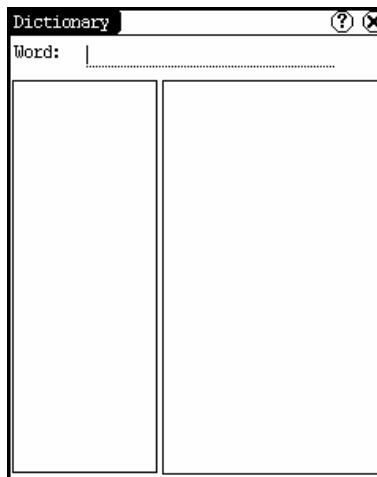

Figure 4-12

World Time

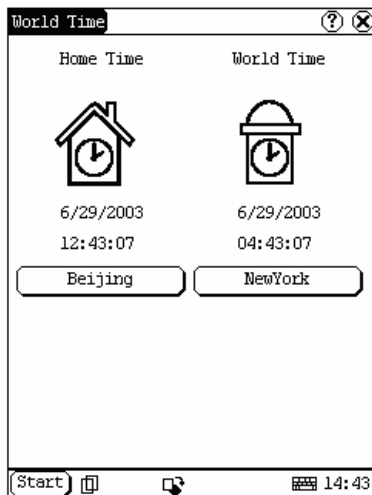

Figure 4-11

- 1) In the pop-up menu of 'Tools', select 'world time' to open the world time interface.
- 2) Click the button under the 'Home Time' icon to select region.
- 3) Click the button under the 'World Time' icon to select region.
- 4) Then you can see the time directly. (See Figure 4-11).

Picture View

- 1) Click [Start] button.
- 2) Select 'Tools' in the pop-up menu. (See Figure 4-13)
- 3) In the pop-up 'Tools' list, select 'Picview' to open the Picture interface.
- 4) In the Picture interface, click  icon in the toolbar on the top. (See Figure 4-14)
- 5) Select directory from the left list interface.
- 6) Select file from the right list interface.
- 7) Click [Parent Dir] button, and you can see the directory of current directory's parent.
- 8) You can see the directory of the picture at the right side of 'Path'.
- 9) You can see the file name of the picture at the right side of 'File'.
- 10) Click [OK] button to open the picture.



Figure 4-13

Game

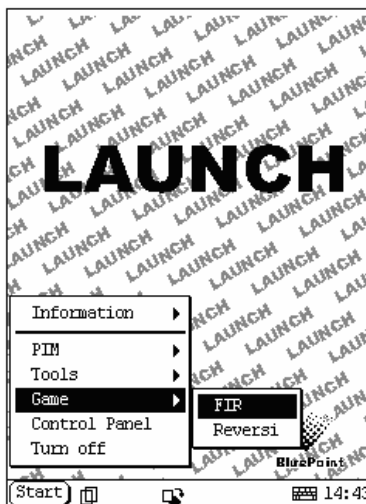

Figure 4-15

- 1) Click [Start] button.
- 2) Select 'Game' in the pop-up menu.
- 3) Select the function in the pop-up submenu. (See Figure 4-15)

FIR

- 1) In the pop-up submenu of 'Game', select 'FIR' to open the Chess Board.
- 2) Click black or white chessman to begin the game. The one who select the black chessman will start first. (See Figure 4-16)



Rules for the game:

You must try to make your five chessmen line up and prevent your adversary from achieving this goal in the process. The one whose 5 chessmen are lined up first is winner. You can choose the black or white chessman at the bottom of the Chess Board before starting playing.



Figure 4-14



Browse the pictures in current directory

- 1) In the Picture interface, click  icon on the top to browse the previous picture.
- 2) In the Picture interface, click  icon on the top to browse the next picture.

Note:

This operation is needed only when more than one picture has been stored.

Zoom in and zoom out:

In the Picture interface, click  or  icon on the top, then you can zoom in or zoom out the current picture at will.

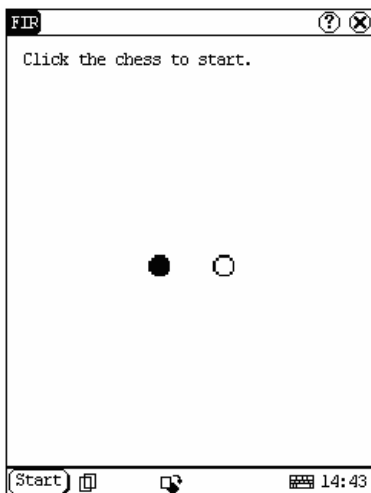

Figure 4-16

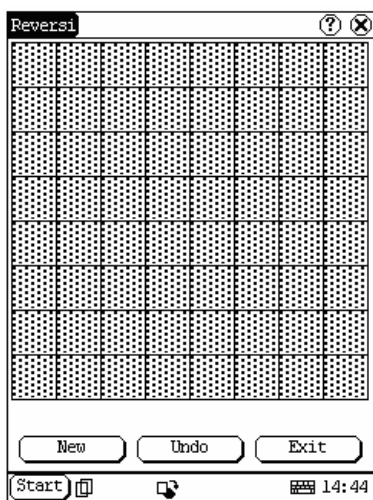

Figure 4-17

Reversi

- 1) In the pop-up menu of 'Game', select 'Reversi' to open the Chess Board. (See Figure 4-17)
- 2) Click [New Game] button to start.
- 3) Click [Undo] button for pull back.
- 4) Click [Close] button to close the Chess Board.

Rule:

The one who chooses white chessman can play first. All black chessmen between two white chessmen will turn to white ones and all white chessmen between two black chessmen will turn to black ones. So the player should be able

to reverse adversary's chessmen in each step. When the chessboard is full of chessmen, the number of the chessmen for each color should be counted. The one who conserve more chessmen on the chessboard is winner.

PIM

- 1) Click [Start] button.
- 2) Select 'PIM' in the pop-up menu.
- 3) Select the function needed in the pop-up list. See Figure 4-18.

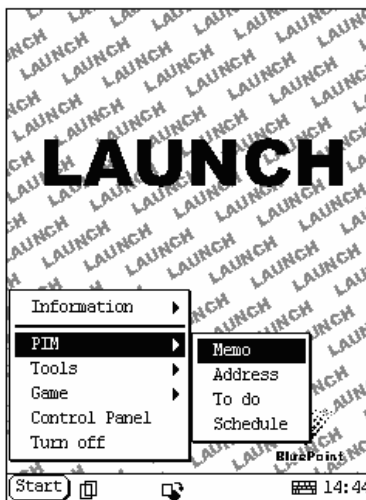

Figure 4-18

Memo

The basic functions of Memo include: add new memo, view memo, delete memo, browse by types, etc.

- 1) In the pop-up 'PIM' list, select 'Memo' to open the Memo interface. (See Figure 4-19)
- 2) After you click the [▼] button on top right corner, the type list will pop up. Then you can select the type of the memo.
- 3) You can also select the Edit Group in the type list to open the Edit Group interface.
- 4) The memo list of corresponding type will be displayed in the list box on the midst of the Memo interface.
- 5) Click one memo in the memo list to open the Memo Edit interface.
- 6) Click [New] button to open the New Memo interface.

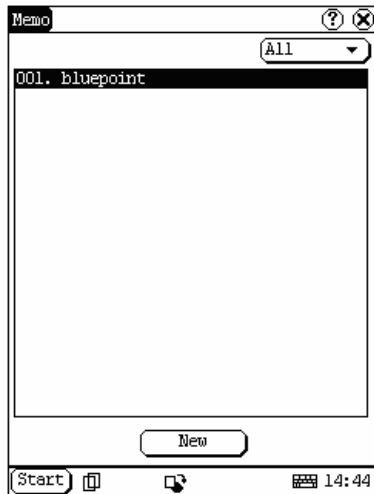

Figure 4-19

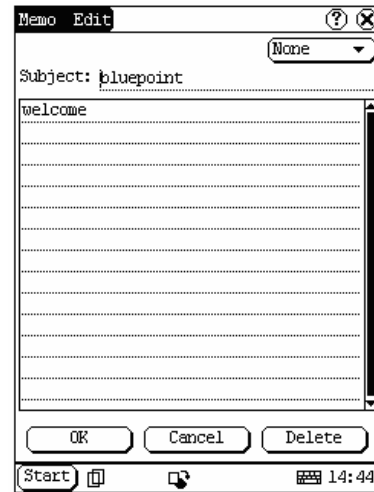

Figure 4-20

Add New Memo

- 1) In the Memo interface, click [New] button to open the New Memo interface.
- 2) Activate Soft Keyboard, and fill the subject and contents.
- 3) Click the button on top right corner, then select the type in the pop-up list
- 4) Click [OK] button to save and close the New Memo interface.
- 5) Then you can see the new memo in the list box of the Memo interface.

View Memo

- 1) In the list box of the Memo interface, click the memo that you want to view.
- 2) Then you can view the contents of the memo in the opened Memo Edit interface.
- 3) Click [OK] button to close the Memo Edit interface.

Edit Memo

- 1) In the list box of the Memo interface, click the memo that you want to edit.
- 2) Then you can edit the contents of the memo in the opened Memo Edit interface. See Figure 4-20.
- 3) After editing, click [OK] button to save the edited contents and close the Memo Edit interface.

Delete Memo

- 1) In the list box of the Memo interface, click the memo that you want to delete.
- 2) Then you can delete the memo in the opened Memo Edit interface.
- 3) Click [Delete] button to delete the memo and close the Memo Edit interface.

Edit Type

- 1) Click the [▼] button on the top right of the interface so that the type list pops up.
- 2) In the type list, select the Edit Group to open the Edit Group interface.
- 3) In the Edit Group interface, activate Soft Keyboard.
- 4) In the text box at the bottom of the interface, input the name of the type.
- 5) Click [Add] button to add a new type and it will be displayed in the list box of the Edit Group interface. (See Figure 4-21)
- 6) Select one type in the list box, and then click [Delete] button to delete it.
- 7) Click [Close] button to close the Edit Group interface.

The interface ④ : It represents the Memo Interface, the New Memo interface and the Memo Edit interface.

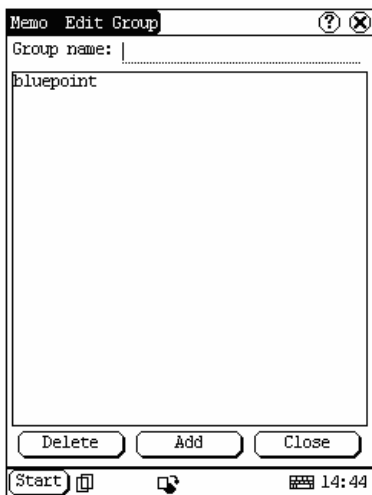

Figure 4-21

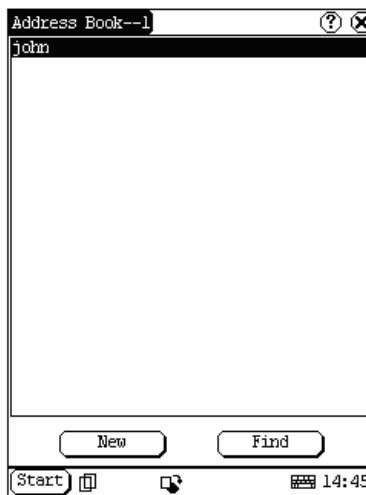

Figure 4-22

Browse By Types

- 1) Click the [▼] button on the top right of the Memo interface so that the type list pops up.
- 2) Select the type in the list.
- 3) Then you can see the memo belonging to the type in the list box.

Note: Only the memo belonging to the type can be displayed here. If you want to browse all memos, please select 'All' in the steps 1 and 2.

Address

The basic functions of Address Book include: add new address, view address, delete address, to search address, etc.

- 1) In the pop-up 'PIM' list, select 'Address' to open the Address Book interface.
- 2) It lists the name of persons whose communication information has been stored.
- 3) Click [New] button to open the Address New interface. (See Figure 4-22)
- 4) Click [Find] button to pop up the Find People interface.

The operation guide for each function is described below:

Add New Address

- 1) In the Address Book interface, click [New] button to open the Address New interface. (See Figure 4-23)
- 2) Activate Soft Keyboard, and fill the detailed information on relatives and friends.
- 3) Click [OK] button to save and close the Address New interface.
- 4) Then the added name will be displayed in the list box of the Address Book interface.

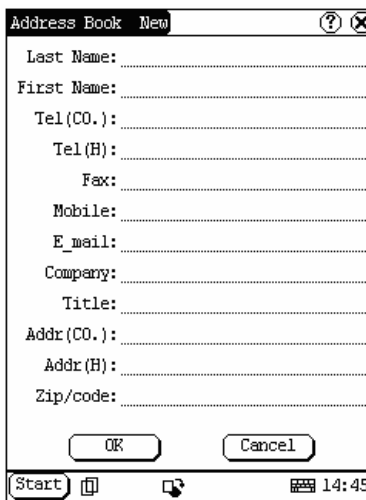

Figure 4-23

View Address

- 1) In the list box of the Address Book interface, click the name that you want to

- view.
- 2) Then the detailed information about the person will be shown in the opened Address Edit interface.
- 3) Click [OK] button to close the Address Edit interface.

- 2) Activate Soft Keyboard, and input the name you want to search.
- 3) Click [OK] button, and then you will see that the name you search is highlighted in the list box.

Edit Address

- 1) In the list box of the Address Book interface, click the name that you want to edit.
- 2) Then the information about the person can be edited in the opened Address Edit interface. See Figure 4-24.
- 3) After editing, click [OK] button to save the edited contents and close the Address Edit interface.

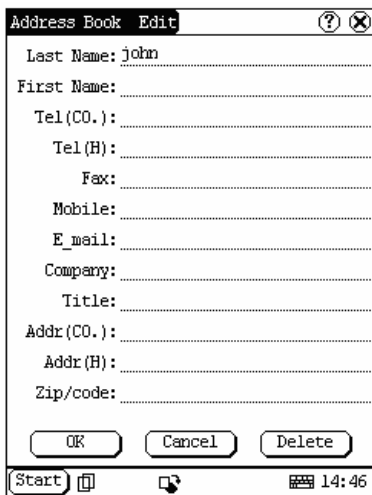

Figure 4-24

Delete Address

- 1) In the list box of the Address Book interface, click the name that you want to delete.
- 2) Then the information about the person will be shown in the opened Address Edit interface.
- 3) Click [Delete] button to delete the person's information and close the Address Edit interface.

Search Address

- 1) In the Address Book interface, click [Find] button to pop up the Find People interface. See Figure 4-25.

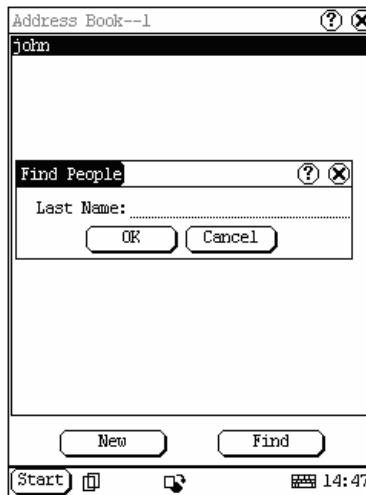

Figure 4-25

To Do

The basic functions of To Do include: add new To Do, view To Do, delete To Do and set To Do, etc.

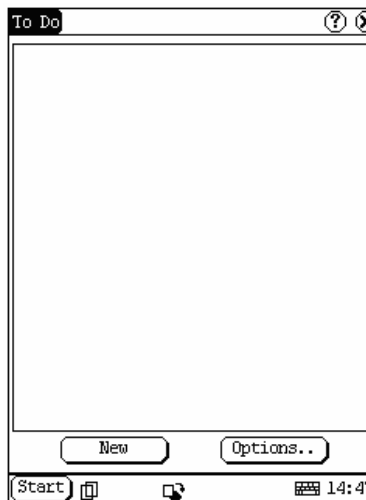

Figure 4-26

- 1) In the pop-up 'PIM' list, select 'To Do' item to open the To Do interface.
- 2) The To Do list of corresponding items will

be displayed in the list box on the midst of the Memo interface.

- 3) Click [Options] button to open the To Do Display interface. (See Figure 4-26)
- 4) Click [New] button to open the To Do New interface.

Add New To Do

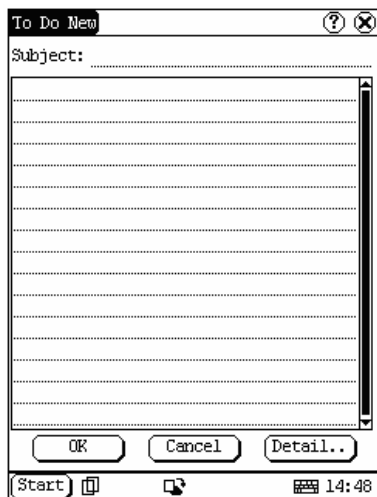

Figure 4-27

- 1) In the To Do interface, click [New] button to open the To Do New interface. See Figure 4-27.
- 2) Activate Soft Keyboard, and fill in the subject and contents.
- 3) Click [Detail] button to open the To Do Detail interface. See Figure 4-28.
- 4) In the To Do Detail interface, click the button to the right of 'Group' to pop up the type list.
- 5) Click the button to the right of 'Expired', and select the data in the pop-up list.
- 6) Click the number to the right of 'Priority' to set the priority of the To Do.
- 7) If the To Do has been finished, please click the box to the right of 'Finished'. When the function is selected, 'X' will be marked in the box,.
- 8) Click [OK] button to save and close the To Do Detail interface.
- 9) In the To Do Detail interface, click [OK] button to save and close the To Do New interface.

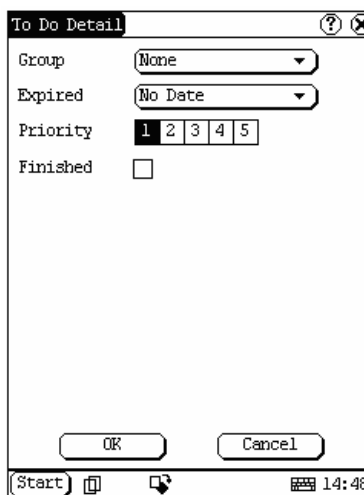

Figure 4-28

View To Do

- 1) In the list box of the To Do interface, click the to do that you want to view.
- 2) Then the contents of the To Do will be shown in the opened To Do Edit interface.
- 3) Click [OK] button to close the To Do Edit interface.

Edit To Do

- 1) In the list box of the To Do interface, click the memo that you want to edit.
- 2) Then the contents of the memo will be shown in the opened To Do Edit interface.
- 3) Click [Detail] button to open the To Do Detail interface, please refer to step 4-8 in the section "Add New To Do".
- 4) After editing, click [OK] button to save the edited contents and close the To Do Edit interface.

Delete To Do

- 1) In the list box of the To Do interface, click the to do that you want to delete.
- 2) Then the contents will be shown in the opened To Do Edit interface.
- 3) Click [Delete] button to delete the To Do and close the To Do Edit interface.

Edit Type

- 1) Click the [▼] button to the right of 'Group' in the interface so that the type list pops up.

- 2) In the type list, select 'Edit Group' to open the Edit Group interface. See Figure 4-29.
- 3) In the Edit Group interface, activate Soft Keyboard.
- 4) In the text box at the bottom of the interface, input the name of the type.
- 5) Click [New] button to add a new type and it will be displayed in the list box of the Edit Group interface.
- 6) Select one type in the list box, and then click [Delete] button to delete it.
- 7) Click [Close] button to close the Edit Group interface.

The interface ④ : It represents the To Do Detail Interface (Refer to step 1-3 in the section "Add New To Do" and "Edit To Do"), and the To Do Display interface (Refer to step 1 in the section "The Set of Display ").

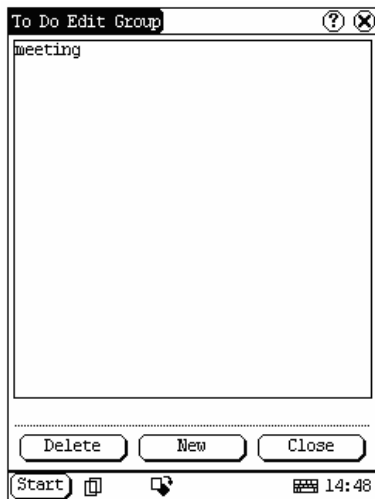

Figure 4-29

The Set of display

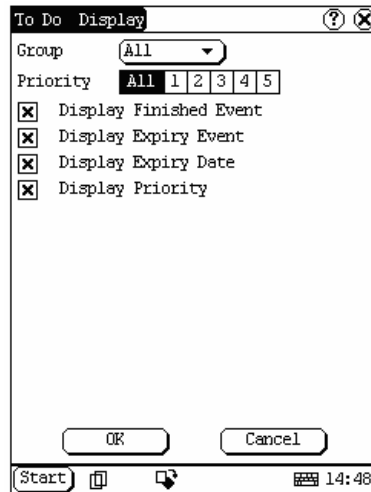

Figure 4-30

- 1) In the To Do interface, click [Options] button to open the To Do Display interface.
- 2) In the To Do Display interface, click the button to the right of 'Group' to pop up type list, and select the type in the pop-up list.
- 3) Click the button to the right of 'Expired', and select the data in the pop-up list.
- 4) Click the number or 'All' to the right of 'Priority' to set the priority of the displayed To Do.
- 5) Click the box to the right of each function. When 'X' is displayed in the box, the function is selected. (See Figure 4-30)
- 6) Click [OK] button to close the To Do Display interface.
- 7) Then you can see the corresponding To Do in the list box of the To Do interface.

Schedule

The basic functions of Schedule include: add new schedule, view schedule, delete schedule, etc.

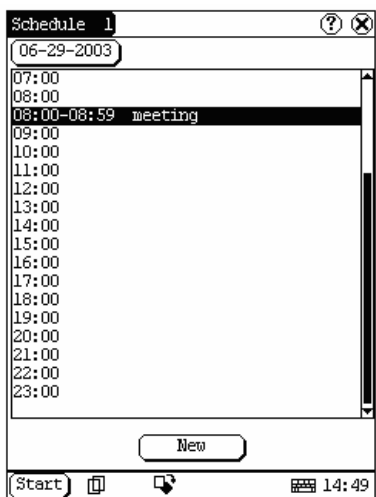

Figure 4-31

- 1) In the pop-up list of 'PIM', select 'Schedule' to open the Schedule interface.
- 2) Click the Date button on the upper left of the interface to open the Select Date interface.
- 3) In the list box in the middle of the interface, all schedules on that day corresponding to the Date button will be displayed. (See Figure 4-31)
- 4) Click [New] button, and then the cycle list pops up. You may select 'Common', 'Daily', 'Weekly', 'Monthly' and 'Annual'.
- 5) In the cycle list, select one item to open the Schedule New interface.

Add New Schedule

Set the date of the schedule:

- 1) In the Schedule interface, click the Date button on the upper left to open the Select Date interface.
- 2) In the Select Date interface, click [◀] icon to the left of the month or year to select the previous month or year.
- 3) Click the [▶] icon to the right of the month or year to select the next month or year. (See Figure 4-32)
- 4) Click to select the date in the current month. When it is highlighted, it is selected.
- 5) Or click [Today] button to display the current year, month and date directly.
- 6) Click [OK] button to save the date setting

and close the Select Date interface.

- 7) You may see the date you set on the button on the top right of the Schedule interface.

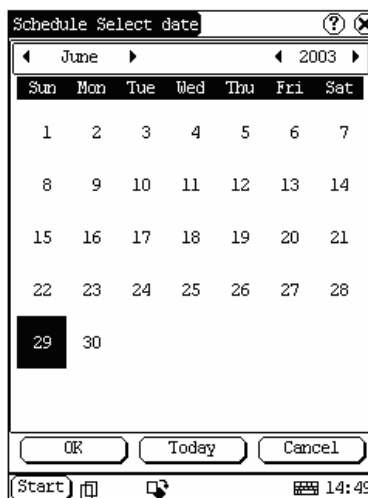

Figure 4-32

Set the cycle of the schedule:

- 1) In the Schedule interface, click [New] button so that the Cycle list pops up. See Figure 4-33.
- 2) In the Cycle list, select 'Common' if it is done on the selected date.
- 3) Select 'Daily' if it is done every day.
- 4) Select 'Weekly' if it is done on a fixed day every week.
- 5) Select 'Monthly' if it is done on a fixed day every month.
- 6) Select 'Annual' if it is done on a fixed day every year.
- 7) After selecting, open the New Schedule interface.

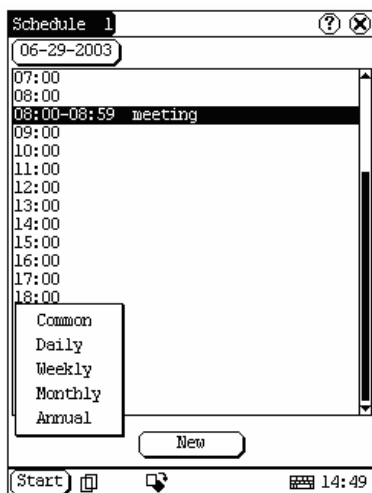

Figure 4-33

Set the content of the schedule:

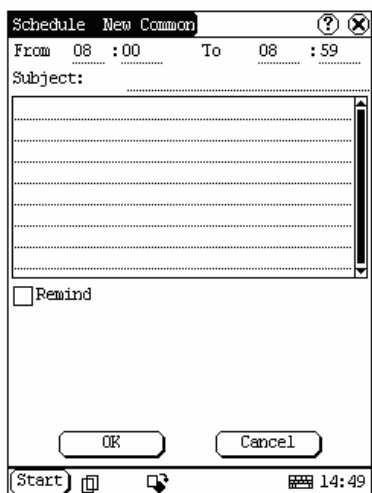

Figure 4-34

- 1) In the Schedule New interface, activate Soft Keyboard, and fill the subject and contents.
- 2) In the textbox on the top of the interface, fill the time of the schedule.
- 3) If the selected cycle is 'Daily', 'Weekly', 'Monthly' or 'Annual', you can input the repeat time in the textbox on the bottom of the interface. See Figure 4-34.
- 4) "Remind" function can be selected and the reminding time can be set in the interface. The "Remind" function will not be available when the machine is turned

off.

- 5) Click [OK] button to save and close the Schedule New interface

View Schedule

- 1) In the Schedule interface, select the date that has been scheduled. (Refer to the section "Add New Schedule → Set the date of the schedule")
- 2) In the list box of the Schedule interface, click Scrolling Bar to turn to next page, and click the schedule you want to view.
- 3) Then the contents of the schedule will be shown in the opened Schedule View interface.
- 4) Click [OK] button to close the Schedule View interface.

Edit Schedule

- 1) In the Schedule interface, select the date that has been scheduled. (Refer to the section "Add New Schedule → Set the date of the schedule")
- 2) In the list box of the Schedule interface, click Scrolling Bar to turn to next page, and click the schedule you want to edit.
- 3) Then the contents of the schedule will be shown in the opened Schedule View interface.
- 4) If the edited affair is 'Daily', 'Weekly', 'Monthly' or 'Annual', you can edit the repeat time in the textbox on the bottom of the interface.
- 5) After editing, click [OK] button to save the edited contents and close the Schedule View interface.

Delete Schedule

- 1) In the Schedule interface, select the date that has been scheduled. (Refer to the section "Add New Schedule → Set the date of the schedule")
- 2) In the list box of the Schedule interface, click Scrolling Bar to turn to next page, and click the schedule you want to edit.
- 3) Then the schedule will be shown in the opened Schedule View interface. See Figure 4-35.
- 4) Click [Delete] button to delete it and close the Schedule View interface.

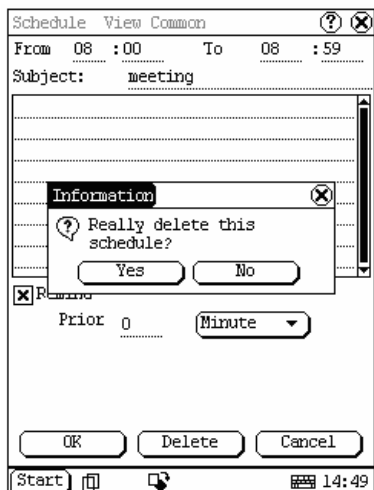

Figure 4-35

System

Control Panel

The control panel includes all interrelated software and hardware configurations. It makes the software more custom-built for you by configuring.

- 1) Click [Start] button.
- 2) Select 'Control Panel' in the pop-up menu.
- 3) Open the Control Panel interface. (See Figure 4-36)

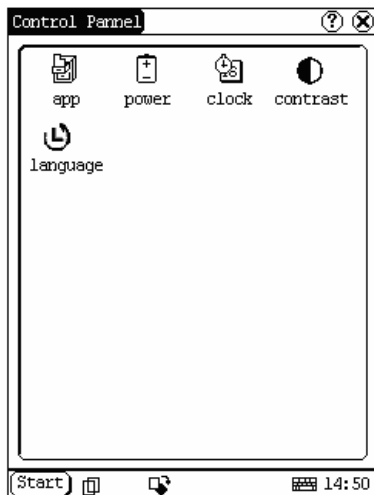

Figure 4-36

Application

It displays the application information contained in the 'Start' menu, including the group name, the submenu, etc.

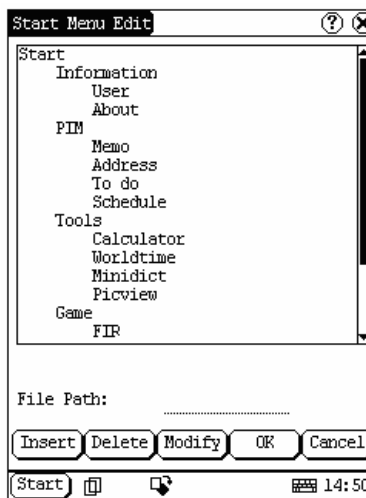

Figure 4-37

- 1) In the Control Panel interface, click 'App' icon to open the Application Manager interface.
- 2) Then you can see the corresponding information in the list box of the interface. (See Figure 4-37)
- 3) Insert a new group: Click [Insert] button and input the item name. Then choose "Start" as its parent and click [OK] button.

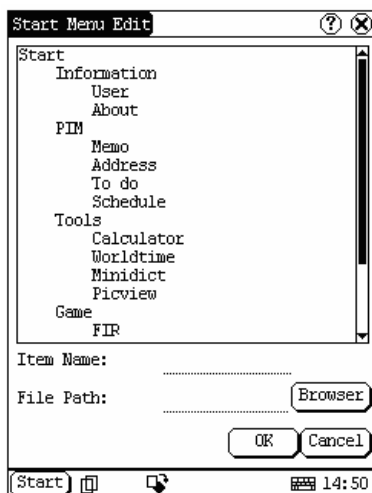

Figure 4-38

- 4) Insert a new submenu:
Click [Insert] button and input the item name and the file path. Then choose a group as its parent and click [OK] button. The path can be inputted directly or found out in a dialogue box after clicking [Browser] button. See Figure 4-38 and Figure 4-39. Click [OK] button after selecting an item in the list. Then the selected file will be automatically copied to the edit box.

The submenu should be linked to a present group instead of the "Start" item or another submenu.
- 5) Delete a group or a submenu:
Select a group or a submenu and then click [Delete] button. When a group is deleted, all of its submenus will be deleted.
- 6) Modify a group or a submenu:
Click [Modify] button and then select the group or submenu from the list. Now you can modify the item name, file path and so on followed by clicking [OK] button.
- 7) Save the information:
After editing the application, click [OK] button. The modified information will be saved in the corresponding file. If you want to quit the modification, click [Cancel] button.

Note:
Quit all other applications before saving the modification.

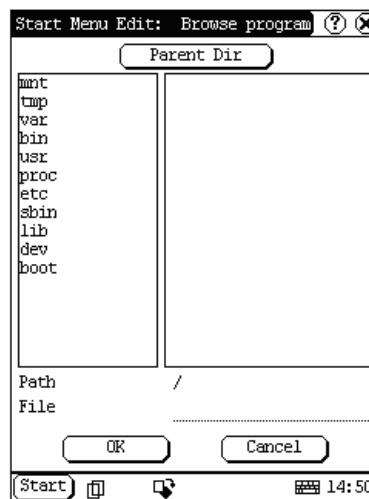

Figure 4-39

Power Management

In the Power Manager interface, you can see the condition of memory, and set the standby time. (See Figure 4-40)

- 1) In the Control Panel interface, click 'Power' icon to open the Power Manager interface.
- 2) Click the button to the right of 'Standby time', and select the time or 'None' in the pop-up list.
- 3) Click [OK] button to save the setting and close the Power Manager interface.

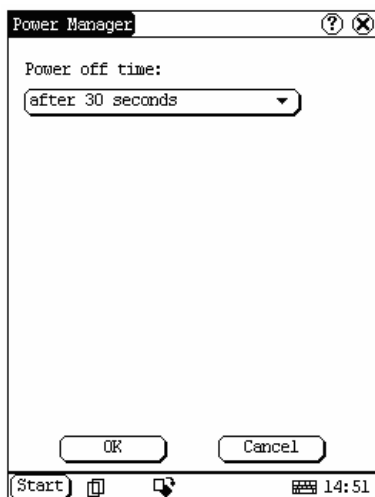

Figure 4-40

Clock

User can set the time and the time zone of the system.



Figure 4-41

Set Time:

- 1) In the Control Panel interface, click 'Clock' icon to open the Date/Time interface as shown in Figure 4-41.
- 2) In the Date/Time interface, click [Set Time] button to open the Set Time interface as shown in Figure 4-42.
- 3) Click the characters to the right of 'Day' to set AM and PM, the selected one will be highlighted.
- 4) Activate Soft Keyboard, and then you can

set 'Hours', 'Minutes' and 'Seconds' directly.

- 5) Click [OK] button to save and close the Set Time interface.

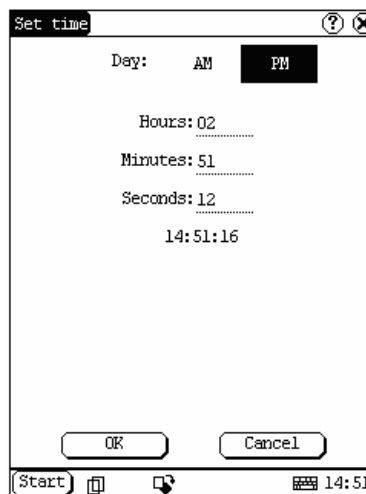

Figure 4-42

Set Date:

- 1) In the Date/Time interface, you can set date directly.
- 2) Click [◀] icon to the left of the month or year to select the previous month or year.
- 3) Click the [▶] icon to the right of the month or year to select the next month or year. (See Figure 4-41)
- 4) Click the date in the current month. It will be highlighted when it is selected.
- 5) Click [Set Time] button to save the setting.
- 6) Click [Quit] button to exit.

Set Time Zone

- 1) In the Date/Time interface, click [Set Time zone] button to open the Set Zone interface as shown in Figure 4-43.
- 2) Click Scrolling Bar to turn to next page of the list, and select your zone. It will be highlighted when it is selected.
- 3) Click [OK] button to save and close the Set Zone interface.



Figure 4-43

After finishing all settings, click [OK] button in the Date/Time interface to exit and close the interface.

Contrast

It is for adjusting the contrast of the screen to make the interface clearer.

- 1) In the Control Panel interface, click 'Contrast' icon to open the Contrast interface. See Figure 4-44.
- 2) In the Contrast interface, click the position you want, and then you can set it.

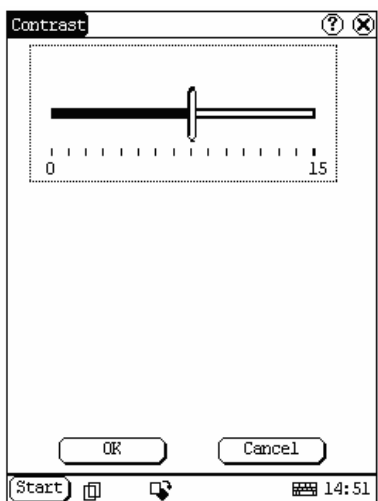

Figure 4-44

Language

You can make selection among several languages for convenient operation of the system.

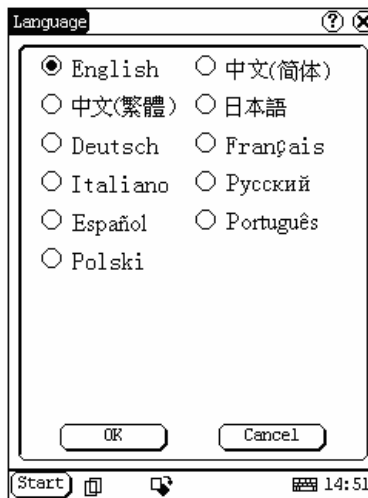

Figure 4-45

- 1) In the Control Panel interface, click 'Language' icon to open the Language interface. See Figure 4-45.
- 2) Select the language you want to use.
- 3) Click [OK] button to confirm the selection and close the language interface and the Control Panel interface.

Note: Before selecting language, be sure to quit all applications.

System Information

Calibrate Touch screen

It is for getting the desired accuracy of the touch screen. Calibrating of touch screen can be divided into two steps. The first step is to detect noise automatically. If you click the touch screen at this step, the noise value would be affected. After detecting the noise, the system will come to the calibration step. Then the cross cursor will be displayed.

- 1) After switching on the machine, follow the tips to press the hot key. The calibration interface will be opened.
- 2) Click the cross cursor on the screen

accurately, and wait until it changes. Then one step of calibration is finished.

- 3) After calibration is finished for all corners, the system will automatically return to the start-up main interface.

Note:

- ◆ Do not click the touch screen before the cross cursor appears.
- ◆ In the calibration step, if you fail to click the cross cursor accurately, the cross cursor will be displayed on the screen again and again until the calibration is finished completely.

User Register

The user's right can be well protected after registration.

- 1) Click [Start] button.
- 2) Select 'Information' in the pop-up menu.
- 3) Select 'User' in the pop-up list to open the User Information interface. (See Figure 4-46)
- 4) In the User Information interface, activate Soft Keyboard, and input the user information. (See Figure 4-47)
- 5) Click [OK] button to save the information and close the User Information interface.

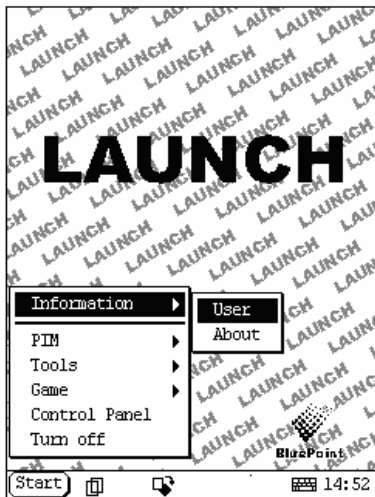

Figure 4-46

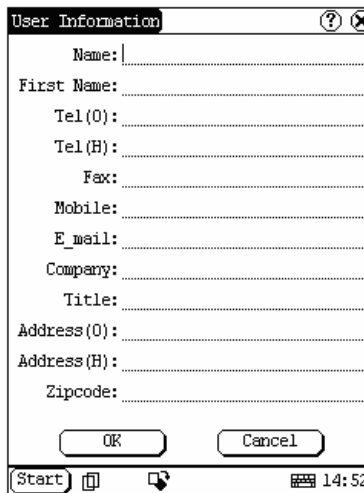

Figure 4-47

About

In 'Information' list, click 'About' to display the information on system software and hardware, then click [OK] button to close it. (See Figure 4-48)

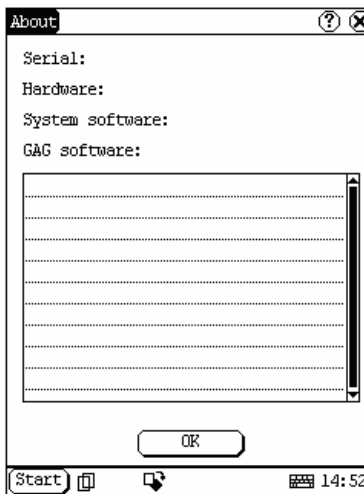

Figure 4-48

Shut Down

Click "Shut Down" in the Start menu when you attempt to turn off the machine.

FAQ

X431 heavy-duty is a hi-tech product. With the development of modern automotive industry, more and more new technology will be adopted and there may be questions during operation. Read the user's manual to get the answer whenever you have any question, or contact our Customer Service Center for help.

Here we list some frequently asked questions and answers relating to X431 heavy-duty.

About Update via Internet

Question: "Removable Disk" icon does not appear in the catalogue of "My computer" after the CF card reader/writer is connected to the USB port of computer. Why?

Answer:

Possible cause: there may not be driver for CF card reader/writer in the computer. The default driver is with the operating systems like Windows Me/2000/XP, Mac OS 9.x/Mac OS X and Linux 2.4.X. However, there is no such default driver with Windows 98.

Solution: Check if there is the driver for CF card reader/writer in the computer. If the computer uses Windows 98 operating system, it is necessary to install the driver into computer by using the CD-ROM provided with CF card reader/writer.

When the CF card reader/writer driver is installed successfully, a "Removable disk" icon will appear in the catalogue of "My computer". Usually it is listed after original disk drive. For example, if there were drives A, B, C and D originally, the removable disk will be "E". If there were drives A, B, C, D and E originally, the removable disk will be "F". The rest may be deduced by analogy.

Question: Some downloaded diagnostic program is not listed in the update tool, what is the reason?

Answer: There are two possible causes:

1. The downloaded diagnostic program is not put in the same folder as other diagnostic programs. Please move it to the same folder as others.
2. The diagnostic program is not fully downloaded. Please download the program again.

Question: When the updated software is used in vehicle diagnosis, some diagnostic program can not be downloaded successfully from the CF card. Why?

Answer: possible causes and solutions:

1. The Display Program may have not been updated. Please update the Display Program.
2. The diagnostic program for the vehicle make is damaged. Please re-download the diagnostic program and update.

Question: Why can't the main unit recognize the replaced CF card?

Answer: There are two possible causes:

1. The original 32M CF card has not been fully copied. Please delete the incomplete file and copy again.
2. The CF card reader/writer is not compatible with the CF card. Monofunctional CF card reader/writer is better in such situation.

Question: How to make a new X431 heavy-duty CF card when the data in old one is lost or damaged?

Answer: In case X431 heavy-duty CF card is damaged and the program in the card can not be used, please use the following procedure to make a new CF card:

1. Log onto the website "www. X431. com". Enter your username and password to log in.

Select the SMARTBOX No., and then download the following programs into your computer:

- 1) Necessary programs for making CF card:

- X431 heavy-duty UPDATE TOOLS---- for writing the program from computer to CF card when doing X431 heavy-duty update
 - DISPLAY PROGRAM---- for displaying the X431 heavy-duty diagnostic information and managing the X431 heavy-duty diagnostic programs
 - SYSTEM DATA---- system data used by X431 heavy-duty system
- 2) Optional programs that can be selected according to user's demand:
Diagnostic program for various vehicles
2. Install the X431 heavy-duty UPDATE TOOLS into computer.
 3. Format the X431 heavy-duty CF card.
 4. Run the X431 heavy-duty UPDATE TOOLS and write the display program, system data and diagnostic programs onto CF card.

About Hardware

Question: After X431 heavy-duty downloads the diagnostic program from the CF card, it prompts "Please contact your local dealer". What is the reason?

Answer: It is because the license No. in CF card does not match the SMARTBOX. It can be solved in the following way:

1. Download the software that is corresponding to the SMARTBOX so that the CF card can match the SMARTBOX.
2. Use the UPDATE TOOL that is provided on <http://www.X431.com> for update. Never use WINZIP or other decompressing tool for update.

Question: Why does the LCD screen respond so slowly?

Answer: It is because the ambient temperature is close to the lower limit of operating temperature range (0-50°C). In this situation, it is necessary to warm up the machine for 20

minutes before test.

Question: Power can not be turned on with the power button on the main unit after the machine is connected to vehicle diagnostic socket through cables and connectors. What can I do?

Answer: Check the power pin of vehicle diagnostic socket with multimeter for power. The power pin in diagnostic socket varies from one vehicle to another. Please refer to the User's Manual of specific vehicle diagnostic program to find the power pin. If there is no power supply from the diagnostic socket, please get power in other ways, such as from battery or cigarette lighter.

Question: There is no character on the backlit screen. What should I do?

Answer: Check if the power is well connected. Turn off the machine, unplug the power connector and re-plug it. Turn on the machine after it has been connected to the power for 1 second.

Question: Why can't the diagnostic program be downloaded to SMARTBOX?

Answer: Please make sure that the SMARTBOX is well connected with X431 heavy-duty main unit.

Question: Why does X431 heavy-duty fail in communication with ECU?

Answer: Please make sure that the diagnostic connector and diagnostic program are matching vehicle make.

Question: The screen keeps blank after flashing when the machine is turned on. What should I do?

Answer: Take out the CF card and re-start the machine to see if there is normal display. If the display is normal when the CF card is taken out, the CF card should be replaced. If the screen is still blank, please contact the local service engineer.

Question: Why does the system prompt that no CF card is found when the machine is turned on?

Answer: The possible cause is that no CF card is in the machine, or CF card is inserted improperly or damaged. If it is damaged, it is necessary to make a new one.

Question: What should I do if I can't get into the diagnostic interface during test?

Answer: The possible cause is that no CF card is in the machine, or CF card is inserted improperly or damaged. If it is damaged, it is necessary to make a new one.

Question: Program is not run or screen is confused after glints. What should I do?

Answer: Unplug the 9-pin connector on the main unit and re-plug it.

Question: What can I do if the system halts or fails during self-detection?

Answer: Please make sure that cables and CF card are well connected.

Question: Why can't the data be inputted after Soft Keyboard is activated?

Answer: The position where the cursor lies can't be edited. Or you have not activated the cursor on the input position. Please use the stylus to click the part to edit. When the cursor twinkles, you can input the data.

Question: The screen is inactive after the cross cursor appears on the screen. Why?

Answer: The system is calibrating the touch screen. The machine will work after the screen is calibrated. Refer to the section "Calibrate Touch Screen" in User's Manual".

Question: Why does the saved data disappear?

Answer: There are two possible causes:

1. Your CF card is damaged.
2. You've changed language and the data is related to language. You may find the data after switching back to the former language.

Question: How to know what applications (interfaces) are opened.

Answer: Click the active taskbar icon, then the pop-up list will display the applications (interfaces) opened.

Question: Why can't I do operation in current interface?

Answer: There are two possible causes:

1. Your current interface has exited illegally. In this situation, you may not see the name of the application (interface) in the pop-up list when you click the active taskbar icon.
2. The system is busy, please wait patiently, or click the active taskbar icon to switch to another application.

Question: The listed icons of vehicle make occupy more than one page of screen. I may have to turn several pages to find a specific icon of vehicle make. How can it be simplified?

Answer: X431 heavy-duty can test many vehicle makes and the vehicle makes are still increasing. We have considered the convenience when designing the software. The system will count the clicks and move the icon with more clicks forward.

About System Setting

Question: The screen is too white and characters can not be seen. What is the reason and what should I do?

Answer: It may be caused by improper contrast. Please refer to the section "Contrast" to adjust the contrast.

Question: The screen is inactive after the cross cursor appears on the screen. Why?

Answer: The system is calibrating the touch screen. The machine will work after the screen is calibrated. Refer to the section "Calibrate Touch Screen" in User's Manual".

Question: The screen does not respond or responds wrongly when I click it with stylus. What should I do?

Answer: It is necessary to calibrate the screen. Please refer to the section "Calibrate Touch Screen" in User's Manual.

Question: The time displayed in the lower right corner of the screen is incorrect. How to adjust it?

Answer: It is because the time was set incorrectly. Please refer to the section "Clock" in the User's Manual to set correct time.

About Operation

Question: System halts when reading data stream. What is the reason?

Answer: It may be caused by a slackened connector. Please turn off the machine, firmly connect the connector, and switch on the machine again.

Question: Why is the screen inactive when the cross cursor is clicked during screen calibration?

Answer: You may have touched the screen when the system is detecting noise before the cross cursor appears. Please turn off the machine and then turn on. Calibrate the screen after the cross cursor appears.

Question: Why is the machine automatically powered off during standby?

Answer: It is because the machine has been set for energy saving. Automatic shutdown will take place if the machine is not operated for a specified period of time. Refer to the section "Power management" in User's Manual to set the "Power off time" to "None" or select a longer

standby time.

Question: Why can't the tested result be printed out?

Answer: There may be no paper in the printer or the printer is not well connected. Please mount a roll of new paper. See the section "Printer Operation" in the User's Manual.

Question: Why is there no character in the printed paper?

Answer: The paper is mounted reversely. Please take out the paper and mount it again. See the section "Printer Operation" in the User's Manual.

Question: Why can't I input data after activating Soft Keyboard?

Answer: The position where the cursor lies can't be edited. Or you have not activated the cursor on the input position. Use the stylus to click the part to edit. When the cursor twinkles, you can input the data.

Question: What should I do if I am not able to switch from Active Taskbar to the running application interface?

Answer: Please close interfaces related to the application, such as the Help or Detail.

Question: Why does the saved data disappear?

Answer: There are two possible causes:
1. Your CF card is damaged. It is necessary to make a new CF card.
2. You've changed language and the data is related to language. You may find the data after switching back to the former language.

Question: What can I do when the screen is confused?

Answer: Please quit the current application (interface), and run it again. If the problem still exists, please restart the system.

Question: How to know what applications (interfaces) are opened.

Answer: Click the active taskbar icon, then the pop-up list will display the applications (interfaces) opened.

Question: Why can't I do operation in current interface?

Answer: There are two possible causes:
1. Your current interface has exited illegally. In this situation, you may not see the name of the application (interface) in the pop-up list when you click the active taskbar icon.
2. The system is busy, please wait patiently, or click the active taskbar icon to switch to another application.

Questions Related to Vehicle

Question: Why does the screen flickers during engine starting?

Answer: It is caused by the electromagnetic interference. No problem with X431 heavy-duty.

Question: Why is operation interrupted during diagnosis?

Answer: It may be caused by electromagnetic interference or incorrect connection of

connector.

Question: Why is there no response from vehicle ECU at communication?

Answer: Make sure that the voltage of vehicle battery, ignition timer and idle speed are in standard range; the throttle is in the closed position; and all electric devices, such as A/C, headlight, stereos etc, are turned off. Refer to the section "Conditions for Test".

Question: Some systems can not be diagnosed. Why?

Answer: The diagnostic socket for the system on some early vehicle may be separated. Refer to the vehicle instruction manual.

Question: No trouble code is found. Why?

Answer: It may be caused by the shared circuit. Find the nearest trouble code and circuit for analysis.

Question: Why are there too many trouble codes?

Answer: It may be caused by poor contact or poor grounding. Make sure that the vehicle model/year is selected correctly and the vehicle is equipped with the system.

Warranty

THIS WARRANTY IS EXPRESSLY LIMITED TO PERSONS WHO PURCHASE LAUNCH PRODUCTS FOR PURPOSES OF RESALE OR USE IN THE ORDINARY COURSE OF THE BUYER'S BUSINESS.

LAUNCH electronic product is warranted against defects in materials and workmanship for one year (12 months) from date of delivery to the user.

This warranty does not cover any part that has been abused, altered, used for a purpose other than for which it was intended, or used in a manner inconsistent with instructions regarding use. The exclusive remedy for any automotive meter found to be defective is repair or replacement, and LAUNCH shall not be liable for any consequential or incidental damages.

Final determination of defects shall be made by LAUNCH in accordance with procedures established by LAUNCH. No agent, employee, or representative of LAUNCH has any authority to bind LAUNCH to any affirmation, representation, or warranty concerning LAUNCH automotive meters, except as stated herein.

Disclaimer

THE ABOVE WARRANTY IS IN LIEU OF ANY OTHER WARRANTY, EXPRESSED OR IMPLIED, INCLUDING ANY WARRANTY OF MERCHANTABILITY OR FITNESS FOR A PARTICULAR PURPOSE.

Order Information

Replaceable and optional parts can be ordered directly from your LAUNCH authorized tool supplier. Your order should include the following

information:

1. Quantity
2. Part number
3. Item description

Customer Service

If you have any questions on the operation of the unit, please contact us:

Tel: 86-755-84528431/84528822

E-mail: X431@cnlaunch.com

If your unit requires repair service, return it to the manufacturer with a copy of the sales receipt and a note describing the problem. If the unit is determined to be in warranty, it will be repaired or replaced at no charge. If the unit is determined to be out of warranty, it will be repaired for a nominal service charge plus return freight. Send the unit pre-paid to:

Attn: Customer Service Department
LAUNCH TECH. CO., LTD.
Launch Industrial Park,
North of Wuhe Avenue,
Banxuegang, Bantian,
Longgang, Shenzhen, Guangdong
P.R.China, 518112

LAUNCH
www.cnlaunch.com